



■ vers. 128



■ vers. 128









■ vers. 128

## SCHEMATICS

---



## TECHNICAL INFORMATION

	<b>COVERING</b>	Leather <input checked="" type="checkbox"/>				
	<b>LEGS</b>	Wood <input checked="" type="checkbox"/>	Metal <input type="checkbox"/>	Plastic <input type="checkbox"/>	Castors <input type="checkbox"/>	Upholstered <input type="checkbox"/>
	<b>FILLING</b>	Arms <input type="checkbox"/> Fiber <input checked="" type="checkbox"/> Foam <input type="checkbox"/> Feather/Fiber Mix <input type="checkbox"/> Feather	Seat cushion <input type="checkbox"/> Fiber <input checked="" type="checkbox"/> Foam <input type="checkbox"/> Feather/Fiber Mix <input type="checkbox"/> Feather	Back cushion <input type="checkbox"/> Fiber <input checked="" type="checkbox"/> Foam <input type="checkbox"/> Feather/Fiber Mix <input type="checkbox"/> Feather		
	<b>COMFORT</b>	Standard Comfort <input checked="" type="checkbox"/>	Firm Comfort <input checked="" type="checkbox"/>			
	<b>FUNCTION</b>	Bed <input type="checkbox"/>	Electric motion <input type="checkbox"/>	Motion <input type="checkbox"/>	Recliner <input type="checkbox"/>	Sliding <input type="checkbox"/>
	<b>OPTIONS</b>	Nails <input type="checkbox"/>	Removable <input type="checkbox"/>	Contrast Stitching <input type="checkbox"/>		

## NOTES

- Tight Back Cushion (the back cushions of the models are fixed to the frame)
- Tight Seat Cushion (the seat cushions of the models are fixed to the frame)
- Wood Frame
- Without Feet Assembled (the feet will be in a bag inside the package)
- Plastic Wrap (the model will be wrapped in a plastic bag)
- Feet available in wood finishings 09 (Walnut) / 18 (Wengè)
- Feet height 16,0 cm

NOTES

---



■ vers. 003



■ vers. 003









■ vers. 003

## SCHEMATICS

---



## TECHNICAL INFORMATION

	<b>COVERING</b>	Leather <input checked="" type="checkbox"/>	Soft Cover <input checked="" type="checkbox"/>			
	<b>LEGS</b>	Wood <input checked="" type="checkbox"/>	Metal <input type="checkbox"/>	Plastic <input type="checkbox"/>	Castors <input type="checkbox"/>	Upholstered <input type="checkbox"/>
	<b>FILLING</b>	Arms <input type="checkbox"/> Fiber <input checked="" type="checkbox"/> Foam <input type="checkbox"/> Feather/Fiber Mix <input type="checkbox"/> Feather	Seat cushion <input type="checkbox"/> Fiber <input checked="" type="checkbox"/> Foam <input type="checkbox"/> Feather/Fiber Mix <input type="checkbox"/> Feather	Back cushion <input type="checkbox"/> Fiber <input checked="" type="checkbox"/> Foam <input type="checkbox"/> Feather/Fiber Mix <input type="checkbox"/> Feather		
	<b>COMFORT</b>	Standard Comfort <input checked="" type="checkbox"/>	Firm Comfort <input type="checkbox"/>			
	<b>FUNCTION</b>	Bed <input type="checkbox"/>	Electric motion <input type="checkbox"/>	Motion <input type="checkbox"/>	Recliner <input type="checkbox"/>	Sliding <input type="checkbox"/>
	<b>OPTIONS</b>	Contrast Stitching <input type="checkbox"/>	Removable <input type="checkbox"/>	Nails <input type="checkbox"/>		

## NOTES

- Model is available with contrast welt to be entered as second covering
- Tight Seat Cushion (the seat cushions of the models are fixed to the frame)
- Tight Back Cushion (the back cushions of the models are fixed to the frame)
- Wood Frame
- Without Feet Assembled (the feet will be in a bag inside the package)
- Plastic Wrap (the model will be wrapped in a plastic bag)
- Feet available in wood finishings 09 (Walnut) / 18 (Wengè)
- Feet height 6,5 cm

NOTES

---





■ vers. 122



■ vers. 222







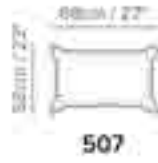

■ vers. 238

### SCHEMATICS

---



## TECHNICAL INFORMATION

	<b>COVERING</b>	Leather <input checked="" type="checkbox"/>	Soft Cover <input checked="" type="checkbox"/>				
	<b>LEGS</b>	Wood <input type="checkbox"/>	Metal <input type="checkbox"/>	Plastic <input type="checkbox"/>	Castors <input type="checkbox"/>	Upholstered <input type="checkbox"/>	
	<b>FILLING</b>	Arms <input type="checkbox"/>	Fiber <input type="checkbox"/> Foam <input type="checkbox"/> Feather/Fiber Mix <input type="checkbox"/> Feather <input type="checkbox"/>	Seat cushion <input checked="" type="checkbox"/>	Fiber <input checked="" type="checkbox"/> Foam <input type="checkbox"/> Feather/Fiber Mix <input type="checkbox"/> Feather <input checked="" type="checkbox"/>	Back cushion <input type="checkbox"/>	Fiber <input type="checkbox"/> Foam <input type="checkbox"/> Feather/Fiber Mix <input type="checkbox"/> Feather <input type="checkbox"/>
	<b>COMFORT</b>	Standard Comfort <input checked="" type="checkbox"/>	Firm Comfort <input type="checkbox"/>				
	<b>FUNCTION</b>	Bed <input type="checkbox"/>	Electric motion <input type="checkbox"/>	Motion <input type="checkbox"/>	Recliner <input type="checkbox"/>	Sliding <input type="checkbox"/>	
	<b>OPTIONS</b>	Nails <input type="checkbox"/>	Removable <input type="checkbox"/>	Contrast Stitching <input type="checkbox"/>			

## NOTES

- Model available with accents fabric Dama, Elliott, Palace, Fiume
- Vers. 504/507 available with accents fabric Cosmatesco cat. 9C
- Behind the pillow is perforated for all versions in leather.
- Version 122 has fibre filling and no welt.
- Version 222 has feather filling and welt.
- Version 238 has feather filling and no welt.
- TWO TONE COVERING OPTIONS:
- 1° COV. = Cushion (only version 222)
- 2° COV. = Welt

NOTES

---



■ vers. 010



■ vers. 100







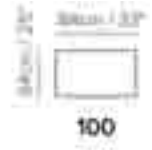
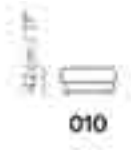

■ vers. 224

## SCHEMATICS

---



## TECHNICAL INFORMATION

	<b>COVERING</b>	Leather <input checked="" type="checkbox"/>	Soft Cover <input checked="" type="checkbox"/>			
	<b>LEGS</b>	Wood <input type="checkbox"/>	Metal <input type="checkbox"/>	Plastic <input checked="" type="checkbox"/>	Castors <input type="checkbox"/>	Upholstered <input type="checkbox"/>
	<b>FILLING</b>	Arms <input type="checkbox"/> Fiber <input checked="" type="checkbox"/> Foam <input type="checkbox"/> Feather/Fiber Mix <input type="checkbox"/> Feather	Seat cushion <input type="checkbox"/> Fiber <input checked="" type="checkbox"/> Foam <input type="checkbox"/> Feather/Fiber Mix <input type="checkbox"/> Feather	Back cushion <input type="checkbox"/> Fiber <input checked="" type="checkbox"/> Foam <input type="checkbox"/> Feather/Fiber Mix <input type="checkbox"/> Feather		
	<b>COMFORT</b>	Standard Comfort <input checked="" type="checkbox"/>	Firm Comfort <input type="checkbox"/>			
	<b>FUNCTION</b>	Bed <input type="checkbox"/>	Electric motion <input type="checkbox"/>	Motion <input type="checkbox"/>	Recliner <input type="checkbox"/>	Sliding <input type="checkbox"/>
	<b>OPTIONS</b>	Contrast Stitching <input type="checkbox"/>	Removable <input type="checkbox"/>	Nails <input type="checkbox"/>		

## NOTES

- Model available with accents fabric Dama, Elliott, Palace, Fiume
- Model also available with thick leather with model code Sxxx (Art. Vesuvio, Cassidy).
- Model also available with slipcover with the model code Rxxx.
- Tight Seat Cushion (the seat cushions of the models are fixed to the frame)
- Wood Frame
- Without Feet Assembled (the feet will be in a bag inside the package)
- Plastic Wrap (the model will be wrapped in a plastic bag)
- Feet height 3,0 cm

NOTES

---





■ vers. 009



■ vers. 000 + 029 + 017



■ vers. 016 + 029 + 017 + 113



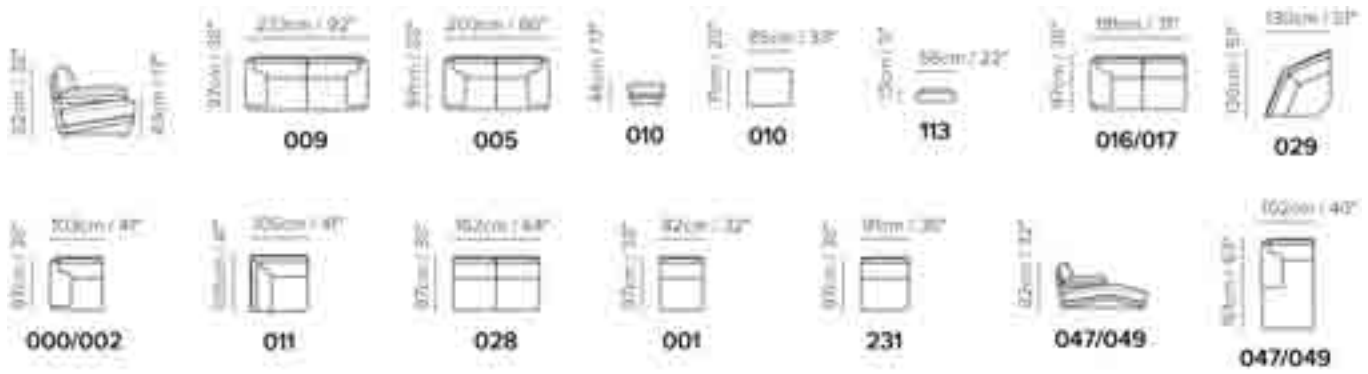

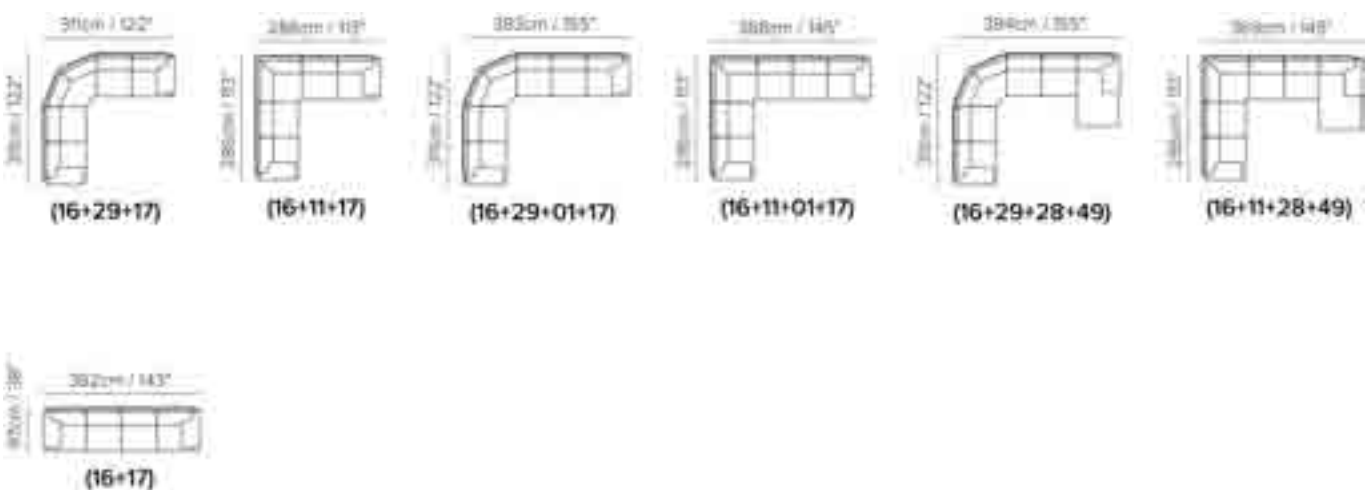

## SCHEMATICS



## COMPOSITION EXAMPLES



## TECHNICAL INFORMATION

	<b>COVERING</b>	Leather <input checked="" type="checkbox"/>	Soft Cover <input checked="" type="checkbox"/>			
	<b>LEGS</b>	Wood <input checked="" type="checkbox"/>	Metal <input checked="" type="checkbox"/>	Plastic <input type="checkbox"/>	Castors <input type="checkbox"/>	Upholstered <input type="checkbox"/>
	<b>FILLING</b>	Arms <input type="checkbox"/> Fiber <input checked="" type="checkbox"/> Foam <input type="checkbox"/> Feather/Fiber Mix <input type="checkbox"/> Feather	Seat cushion <input type="checkbox"/> Fiber <input checked="" type="checkbox"/> Foam <input type="checkbox"/> Feather/Fiber Mix <input type="checkbox"/> Feather	Back cushion <input type="checkbox"/> Fiber <input checked="" type="checkbox"/> Foam <input type="checkbox"/> Feather/Fiber Mix <input type="checkbox"/> Feather		
	<b>COMFORT</b>	Standard Comfort <input checked="" type="checkbox"/>	Firm Comfort <input checked="" type="checkbox"/>			
	<b>FUNCTION</b>	Bed <input type="checkbox"/>	Electric motion <input type="checkbox"/>	Motion <input type="checkbox"/>	Recliner <input type="checkbox"/>	Sliding <input type="checkbox"/>
	<b>OPTIONS</b>	Nails <input type="checkbox"/>	Removable <input type="checkbox"/>	Contrast Stitching <input type="checkbox"/>		

## NOTES

- Tight Seat Cushion (the seat cushions of the models are fixed to the frame)
- Tight Back Cushion (the back cushions of the models are fixed to the frame)
- No Leather Side (the sectional pieces have the side covered with fabric and not leather)
- Wood Frame
- Without Feet Assembled (the feet will be in a bag inside the package)
- Plastic Wrap (the model will be wrapped in a plastic bag)
- Feet available in wood finishings 09 (Walnut) / 18 (Wengè)
- Feet available in metal finishing 75 (Glazed Nickel)
- Feet height 6,5 cm

NOTES

---



■ vers. 009



■ vers. 216 + 221 + 207



■ vers. 008



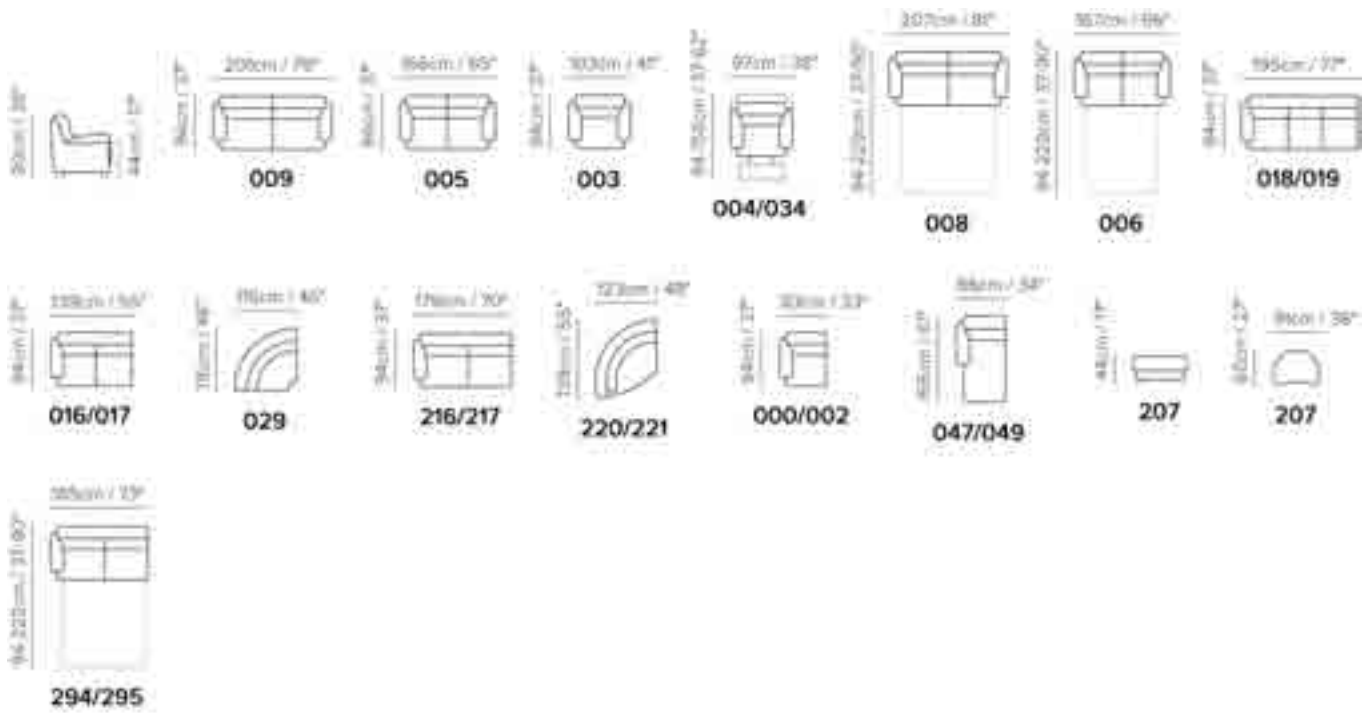



## SCHEMATICS



## COMPOSITION EXAMPLES



## TECHNICAL INFORMATION

	<b>COVERING</b>	Leather <input checked="" type="checkbox"/>	Soft Cover <input checked="" type="checkbox"/>			
	<b>LEGS</b>	Wood <input checked="" type="checkbox"/>	Metal <input type="checkbox"/>	Plastic <input type="checkbox"/>	Castors <input type="checkbox"/>	Upholstered <input type="checkbox"/>
	<b>FILLING</b>	Arms <input checked="" type="checkbox"/> Fiber <input type="checkbox"/> Foam <input type="checkbox"/> Feather/Fiber Mix <input type="checkbox"/> Feather	Seat cushion <input type="checkbox"/> Fiber <input checked="" type="checkbox"/> Foam <input type="checkbox"/> Feather/Fiber Mix <input type="checkbox"/> Feather	Back cushion <input checked="" type="checkbox"/> Fiber <input type="checkbox"/> Foam <input type="checkbox"/> Feather/Fiber Mix <input type="checkbox"/> Feather		
	<b>COMFORT</b>	Standard Comfort <input checked="" type="checkbox"/>	Firm Comfort <input checked="" type="checkbox"/>			
	<b>FUNCTION</b>	Bed <input checked="" type="checkbox"/>	Electric motion <input type="checkbox"/>	Motion <input type="checkbox"/>	Recliner <input checked="" type="checkbox"/>	Sliding <input type="checkbox"/>
	<b>OPTIONS</b>	Contrast Stitching <input type="checkbox"/>	Removable <input type="checkbox"/>	Nails <input type="checkbox"/>		

## BED MECHANISM & MATTRESS

MECHANISM		MATTRESS		
VERSIONS	TYPE	VERSIONS	TYPE	DIMENSIONS
				W L H
006	Electro-welded - Double folding	006	Spring	93 182 12
008	Electro-welded - Double folding	294,295	Polyurethane foam	133 182 7
294,295	Metal Mesh - Triple Folding	008	Spring	133 182 12

## NOTES

- Tight Seat Cushion (the seat cushions of the models are fixed to the frame)
- Tight Back Cushion (the back cushions of the models are fixed to the frame)
- No Leather Side (the sectional pieces have the side covered with fabric and not leather)
- Wood Frame
- Without Feet Assembled (the feet will be in a bag inside the package)
- Plastic Wrap (the model will be wrapped in a plastic bag)
- Feet available in wood finishings 09 (Walnut) / 18 (Wengè)
- Feet height 6,5 cm







■ vers. 009



■ vers. 009







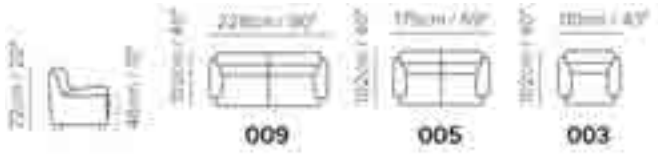

■ vers. 003

## SCHEMATICS

---



## TECHNICAL INFORMATION

	<b>COVERING</b>	Leather <input checked="" type="checkbox"/>				
	<b>LEGS</b>	Wood <input checked="" type="checkbox"/>	Metal <input type="checkbox"/>	Plastic <input type="checkbox"/>	Castors <input type="checkbox"/>	Upholstered <input type="checkbox"/>
	<b>FILLING</b>	Arms <input type="checkbox"/> Fiber <input checked="" type="checkbox"/> Foam <input type="checkbox"/> Feather/Fiber Mix <input type="checkbox"/> Feather	Seat cushion <input type="checkbox"/> Fiber <input checked="" type="checkbox"/> Foam <input checked="" type="checkbox"/> Feather/Fiber Mix <input type="checkbox"/> Feather	Back cushion <input type="checkbox"/> Fiber <input checked="" type="checkbox"/> Foam <input type="checkbox"/> Feather/Fiber Mix <input type="checkbox"/> Feather		
	<b>COMFORT</b>	Standard Comfort <input checked="" type="checkbox"/>	Firm Comfort <input checked="" type="checkbox"/>			
	<b>FUNCTION</b>	Bed <input type="checkbox"/>	Electric motion <input type="checkbox"/>	Motion <input type="checkbox"/>	Recliner <input type="checkbox"/>	Sliding <input type="checkbox"/>
	<b>OPTIONS</b>	Nails <input type="checkbox"/>	Removable <input type="checkbox"/>	Contrast Stitching <input type="checkbox"/>		

## NOTES

- Firm comfort option is available only for Italy.
- Loose Seat Cushion (the seat cushions of the model are not fixed to the frame)
- Tight Back Cushion (the back cushions of the models are fixed to the frame)
- Wood Frame
- Without Feet Assembled (the feet will be in a bag inside the package)
- Plastic Wrap (the model will be wrapped in a plastic bag)
- Feet available in wood finishings 09 (Walnut) / 18 (Wengè)
- Feet height 6,5 cm

NOTES

---



■ vers. 009



■ vers. 008



■ vers. 016 + 011 + 028 + 049



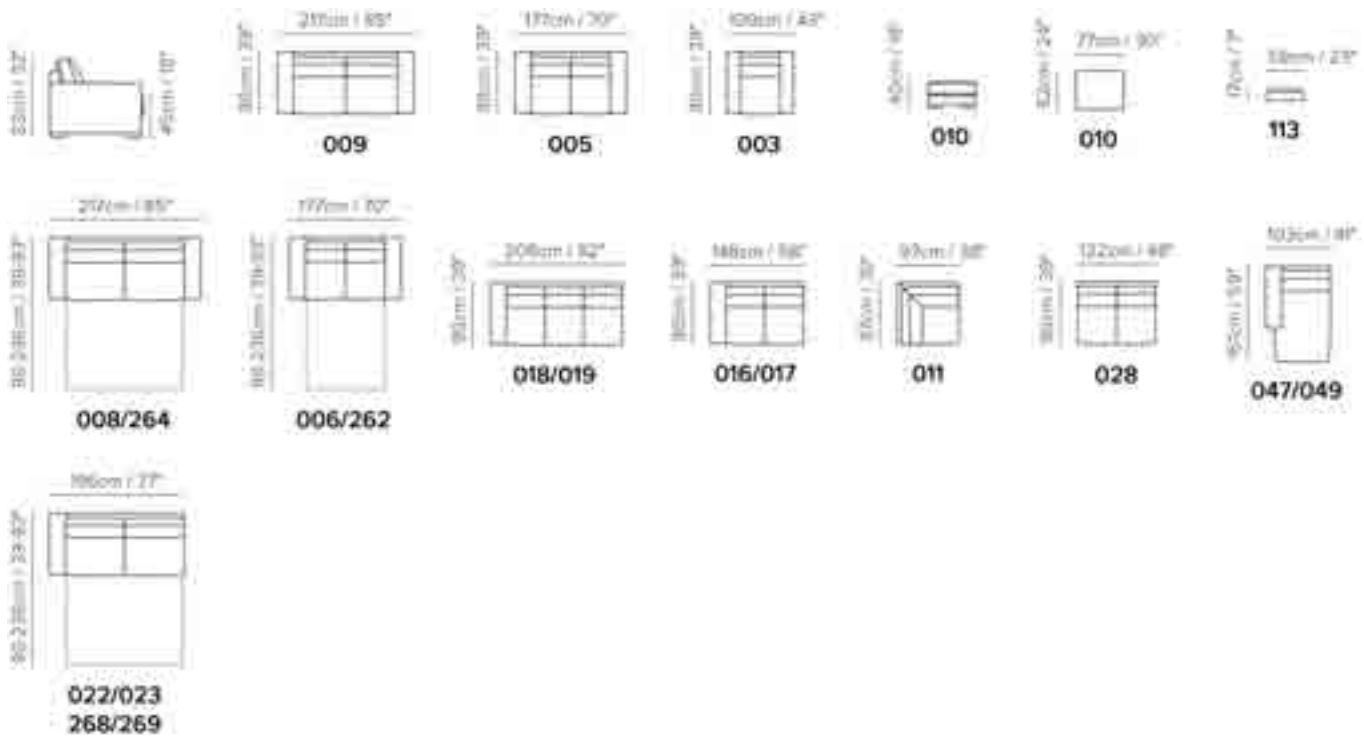



## SCHEMATICS



## COMPOSITION EXAMPLES



## TECHNICAL INFORMATION

	<b>COVERING</b>	Leather <input checked="" type="checkbox"/>	Soft Cover <input checked="" type="checkbox"/>			
	<b>LEGS</b>	Wood <input checked="" type="checkbox"/>	Metal <input type="checkbox"/>	Plastic <input type="checkbox"/>	Castors <input type="checkbox"/>	Upholstered <input type="checkbox"/>
	<b>FILLING</b>	Arms <input type="checkbox"/> Fiber <input checked="" type="checkbox"/> Foam <input type="checkbox"/> Feather/Fiber Mix <input type="checkbox"/> Feather	Seat cushion <input type="checkbox"/> Fiber <input checked="" type="checkbox"/> Foam <input type="checkbox"/> Feather/Fiber Mix <input type="checkbox"/> Feather	Back cushion <input type="checkbox"/> Fiber <input checked="" type="checkbox"/> Foam <input type="checkbox"/> Feather/Fiber Mix <input type="checkbox"/> Feather		
	<b>COMFORT</b>	Standard Comfort <input checked="" type="checkbox"/>	Firm Comfort <input checked="" type="checkbox"/>			
	<b>FUNCTION</b>	Bed <input checked="" type="checkbox"/>	Electric motion <input type="checkbox"/>	Motion <input type="checkbox"/>	Recliner <input type="checkbox"/>	Sliding <input type="checkbox"/>
	<b>OPTIONS</b>	Contrast Stitching <input type="checkbox"/>	Removable <input type="checkbox"/>	Nails <input type="checkbox"/>		

## BED MECHANISM & MATTRESS

MECHANISM		MATTRESS		
VERSIONS	TYPE	VERSIONS	TYPE	DIMENSIONS
				W L H
006,262	Transformable electro-welded - Double folding	262	GREENPLUS	100 190 12
008,264	Transformable electro-welded - Double folding	006	Spring	100 190 12
022,023,268,269	Transformable electro-welded - Double folding	022,023	Spring	139 190 12
		264,268,269	GREENPLUS	140 190 12
		008	Spring	140 190 12

**Transformable electro-welded  
GREENPLUS**

The back cushion remains fixed at the head, creating a comfortable support.

GREENPLUS mattress is a patented, innovative product. It is ecological, made up of microporous elastomers. It has a great adaptation capacity to the various body pressure which gives big support to the spine. It is antibacterial and no-allergic.

## NOTES

- Model also available with slipcover with the model code Rxxx.
- Tight Seat Cushion (the seat cushions of the models are fixed to the frame)
- Tight Back Cushion (the back cushions of the models are fixed to the frame)
- No Leather Side (the sectional pieces have the side covered with fabric and not leather)
- Wood Frame
- Without Feet Assembled (the feet will be in a bag inside the package)
- Plastic Wrap (the model will be wrapped in a plastic bag)
- Feet available in wood finishings 09 (Walnut) / 18 (Wengè)
- Feet height 4,5 cm
- Headrest available on versions 003/005/009/016/017/018/019/047/049

NOTES

---





■ vers. 225 + 198 + 001 + 223



■ vers. 225 + 198 + 049



■ vers. 047 + 198 + 029 + 198 + 001 + 223



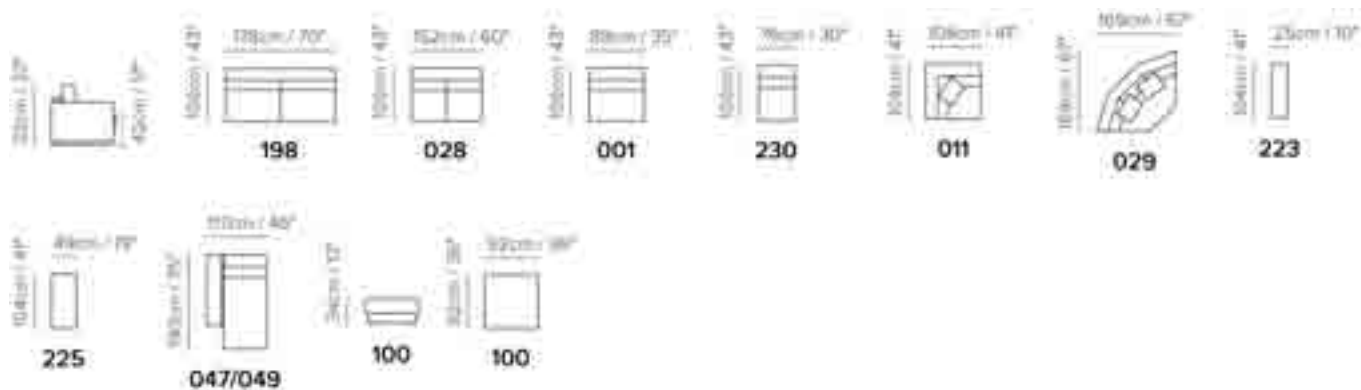

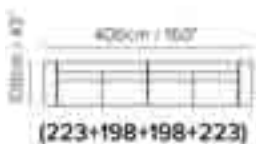

## SCHEMATICS



## COMPOSITION EXAMPLES



## TECHNICAL INFORMATION

	<b>COVERING</b>	Mix <input checked="" type="checkbox"/>	Leather <input checked="" type="checkbox"/>	Soft Cover <input checked="" type="checkbox"/>		
	<b>LEGS</b>	Wood <input checked="" type="checkbox"/>	Metal <input type="checkbox"/>	Plastic <input type="checkbox"/>	Castors <input type="checkbox"/>	Upholstered <input type="checkbox"/>
	<b>FILLING</b>	Arms <input type="checkbox"/> Fiber <input checked="" type="checkbox"/> Foam <input type="checkbox"/> Feather/Fiber Mix <input type="checkbox"/> Feather	Seat cushion <input type="checkbox"/> Fiber <input checked="" type="checkbox"/> Foam <input checked="" type="checkbox"/> Feather/Fiber Mix <input type="checkbox"/> Feather	Back cushion <input type="checkbox"/> Fiber <input checked="" type="checkbox"/> Foam <input checked="" type="checkbox"/> Feather/Fiber Mix <input type="checkbox"/> Feather		
	<b>COMFORT</b>	Standard Comfort <input checked="" type="checkbox"/>	Firm Comfort <input checked="" type="checkbox"/>			
	<b>FUNCTION</b>	Bed <input type="checkbox"/>	Electric motion <input type="checkbox"/>	Motion <input type="checkbox"/>	Recliner <input type="checkbox"/>	Sliding <input type="checkbox"/>
	<b>OPTIONS</b>	Nails <input type="checkbox"/>	Removable <input type="checkbox"/>	Contrast Stitching <input type="checkbox"/>		

## NOTES

- Model also available with slipcover with the model code Rxxx.
- Firm comfort option is available only for Italy.
- Loose Seat Cushion (the seat cushions of the model are not fixed to the frame)
- Seat cushion includes a layer of memory foam, a pressure-sensitive soft polyurethane, that recovers its form completely thus giving great comfort
- With Leather Side (the sectional pieces come with leather sides)
- Wood Frame
- Without Feet Assembled (the feet will be in a bag inside the package)
- Feet available in wood finishings 09 (Walnut) / 18 (Wengè)
- Feet height 6,5 cm
- Version 029 includes 2 small cushions.
- Version 011 includes 1 small cushion.
- LEATHER-FABRIC MIX COVERING OPTIONS:
- 1° COV. (Leather) = Frame and welt
- 2° COV. (Fabric) = Small pillow, seat and back cushions
- TWO TONE COVERING OPTIONS IN FABRIC:
- 1° COV. = Frame
- 2° COV. = Small pillow, seat and back cushions

NOTES

---



■ vers. 003



■ vers. 003









■ vers. 003

## SCHEMATICS

---



## TECHNICAL INFORMATION

	<b>COVERING</b>	Leather <input checked="" type="checkbox"/>	Soft Cover <input checked="" type="checkbox"/>			
	<b>LEGS</b>	Wood <input type="checkbox"/>	Metal <input checked="" type="checkbox"/>	Plastic <input type="checkbox"/>	Castors <input type="checkbox"/>	Upholstered <input type="checkbox"/>
	<b>FILLING</b>	Arms <input type="checkbox"/> Fiber <input checked="" type="checkbox"/> Foam <input type="checkbox"/> Feather/Fiber Mix <input type="checkbox"/> Feather	Seat cushion <input type="checkbox"/> Fiber <input checked="" type="checkbox"/> Foam <input checked="" type="checkbox"/> Feather/Fiber Mix <input type="checkbox"/> Feather	Back cushion <input type="checkbox"/> Fiber <input checked="" type="checkbox"/> Foam <input checked="" type="checkbox"/> Feather/Fiber Mix <input type="checkbox"/> Feather		
	<b>COMFORT</b>	Standard Comfort <input checked="" type="checkbox"/>	Firm Comfort <input type="checkbox"/>			
	<b>FUNCTION</b>	Bed <input type="checkbox"/>	Electric motion <input type="checkbox"/>	Motion <input type="checkbox"/>	Recliner <input type="checkbox"/>	Sliding <input type="checkbox"/>
	<b>OPTIONS</b>	Contrast Stitching <input type="checkbox"/>	Removable <input type="checkbox"/>	Nails <input type="checkbox"/>		

## NOTES

- Seat cushion includes a layer of memory foam, a pressure-sensitive soft polyurethane, that recovers its form completely thus giving great comfort
- Loose Seat Cushion (the seat cushions of the model are not fixed to the frame)
- Back Cushion Zippered (the back cushion is attached to the frame through a zipper)
- Wood Frame
- Without Feet Assembled (the feet will be in a bag inside the package)
- Metal base available in finishing 75 (Glazed Nickel)

NOTES

---





■ vers. 009



■ vers. 016 + 011 + 017



■ vers. 000 + 001 + 100 + 073



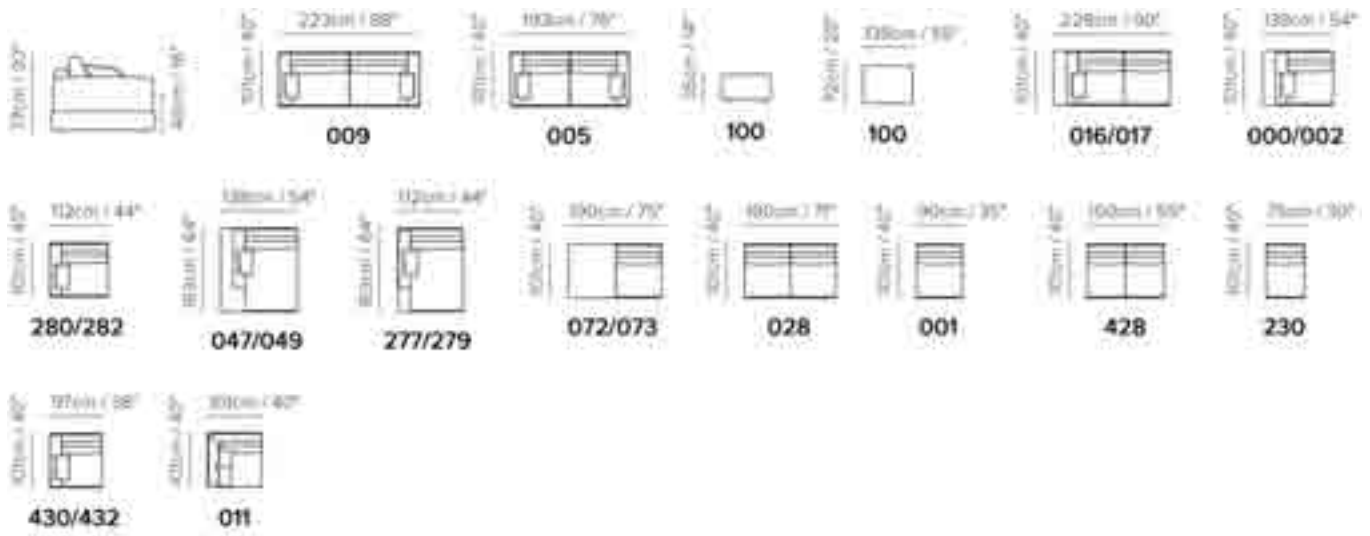

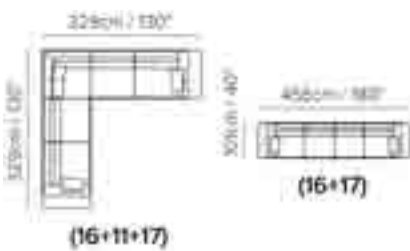

## SCHEMATICS



## COMPOSITION EXAMPLES



## TECHNICAL INFORMATION

	<b>COVERING</b>	Mix <input checked="" type="checkbox"/>	Leather <input checked="" type="checkbox"/>	Soft Cover <input checked="" type="checkbox"/>		
	<b>LEGS</b>	Wood <input type="checkbox"/>	Metal <input type="checkbox"/>	Plastic <input checked="" type="checkbox"/>	Castors <input type="checkbox"/>	Upholstered <input type="checkbox"/>
	<b>FILLING</b>	Arms <input type="checkbox"/> Fiber <input checked="" type="checkbox"/> Foam <input checked="" type="checkbox"/> Feather/Fiber Mix <input type="checkbox"/> Feather	Seat cushion <input type="checkbox"/> Fiber <input checked="" type="checkbox"/> Foam <input checked="" type="checkbox"/> Feather/Fiber Mix <input type="checkbox"/> Feather	Back cushion <input type="checkbox"/> Fiber <input checked="" type="checkbox"/> Foam <input checked="" type="checkbox"/> Feather/Fiber Mix <input type="checkbox"/> Feather		
	<b>COMFORT</b>	Standard Comfort <input checked="" type="checkbox"/>	Firm Comfort <input type="checkbox"/>			
	<b>FUNCTION</b>	Bed <input type="checkbox"/>	Electric motion <input type="checkbox"/>	Motion <input type="checkbox"/>	Recliner <input type="checkbox"/>	Sliding <input type="checkbox"/>
	<b>OPTIONS</b>	Nails <input type="checkbox"/>	Removable <input type="checkbox"/>	Contrast Stitching <input type="checkbox"/>		

## NOTES

- Loose Seat Cushion (the seat cushions of the model are not fixed to the frame)
- Back Cushion Zippered (the back cushion is attached to the frame through a zipper)
- With Leather Side (the sectional pieces come with leather sides)
- Wood Frame
- Without Feet Assembled (the feet will be in a bag inside the package)
- Plastic Wrap (the model will be wrapped in a plastic bag)
- Feet height 4,0 cm
- Second option versions (280-282-430-432-277-279) are without extension of the front/side base.
- Versions 000/002/016/017/047/049/277/279/280/282/430/432 include 1 small cushion.
- Versions 005/009 include 2 small cushions.
- LEATHER-FABRIC MIX COVERING OPTIONS:
- 1° COV. (Leather) = Frame
- 2° COV. (Fabric) = Seat cushion and loose arm cushions
- 3° COV. (Fabric) = Back cushions
- THREE TONE COVERING OPTION IN FABRIC:
- 1° COV. = Frame
- 2° COV. = Seat cushions and small cushions
- 3° COV. = Back cushions

NOTES

---



■ vers. 009



■ vers. 009



■ vers. 047 + 019



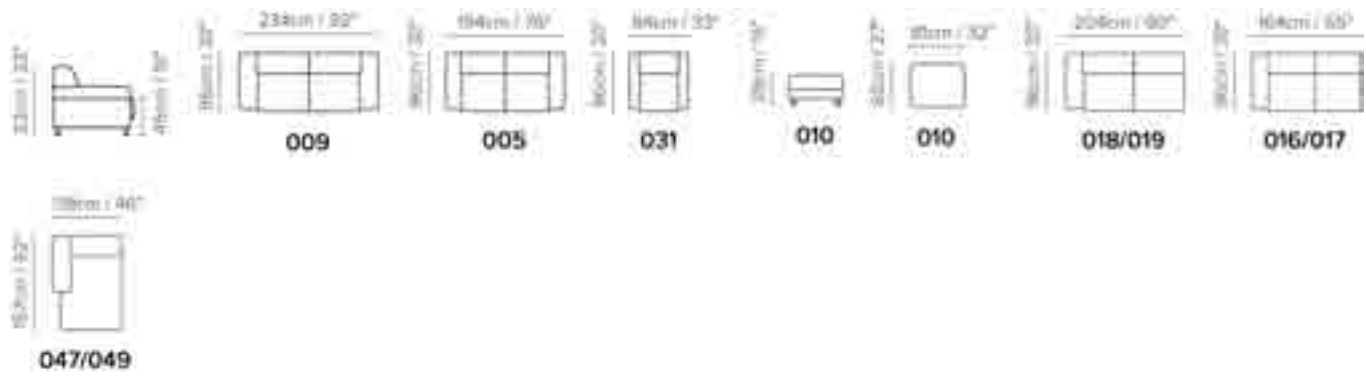

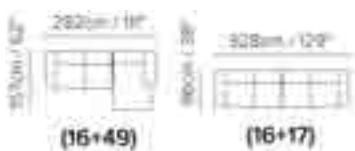

## SCHEMATICS



## COMPOSITION EXAMPLES



## TECHNICAL INFORMATION

	<b>COVERING</b>	Leather <input checked="" type="checkbox"/>					
	<b>LEGS</b>	Wood <input checked="" type="checkbox"/>	Metal <input type="checkbox"/>	Plastic <input type="checkbox"/>	Castors <input type="checkbox"/>	Upholstered <input type="checkbox"/>	
	<b>FILLING</b>	Arms <input type="checkbox"/> Fiber <input checked="" type="checkbox"/> Foam <input checked="" type="checkbox"/> Feather/Fiber Mix <input type="checkbox"/> Feather	Seat cushion <input type="checkbox"/> Fiber <input checked="" type="checkbox"/> Foam <input checked="" type="checkbox"/> Feather/Fiber Mix <input type="checkbox"/> Feather	Back cushion <input type="checkbox"/> Fiber <input checked="" type="checkbox"/> Foam <input checked="" type="checkbox"/> Feather/Fiber Mix <input type="checkbox"/> Feather			
	<b>COMFORT</b>	Standard Comfort <input checked="" type="checkbox"/>	Firm Comfort <input type="checkbox"/>				
	<b>FUNCTION</b>	Bed <input type="checkbox"/>	Electric motion <input type="checkbox"/>	Motion <input type="checkbox"/>	Recliner <input type="checkbox"/>	Sliding <input type="checkbox"/>	
	<b>OPTIONS</b>	Contrast Stitching <input type="checkbox"/>	Removable <input type="checkbox"/>	Nails <input type="checkbox"/>			

## NOTES

- Seat cushion includes a layer of memory foam, a pressure-sensitive soft polyurethane, that recovers its form completely thus giving great comfort
- Tight Seat Cushion (the seat cushions of the models are fixed to the frame)
- Tight Back Cushion (the back cushions of the models are fixed to the frame)
- No Leather Side (the sectional pieces have the side covered with fabric and not leather)
- Wood Frame
- Without Feet Assembled (the feet will be in a bag inside the package)
- Plastic Wrap (the model will be wrapped in a plastic bag)
- Front feet are slightly higher in respect to rear.
- Feet available in wood finishings 09 (Walnut) / 18 (Wengè)
- Feet height 8,0/7,0 cm

NOTES

---





■ vers. 003



■ vers. 003







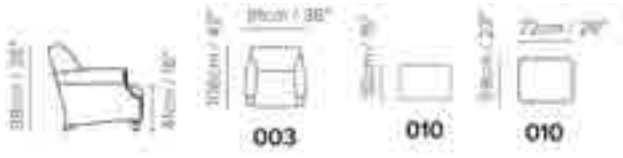

■ vers. 003 + 010

## SCHEMATICS

---



## TECHNICAL INFORMATION

	<b>COVERING</b>	Mix <input checked="" type="checkbox"/>	Leather <input checked="" type="checkbox"/>	Soft Cover <input checked="" type="checkbox"/>		
	<b>LEGS</b>	Wood <input checked="" type="checkbox"/>	Metal <input type="checkbox"/>	Plastic <input type="checkbox"/>	Castors <input type="checkbox"/>	Upholstered <input type="checkbox"/>
	<b>FILLING</b>	Arms <input type="checkbox"/> Fiber <input checked="" type="checkbox"/> Foam <input type="checkbox"/> Feather/Fiber Mix <input type="checkbox"/> Feather	Seat cushion <input type="checkbox"/> Fiber <input checked="" type="checkbox"/> Foam <input type="checkbox"/> Feather/Fiber Mix <input type="checkbox"/> Feather	Back cushion <input type="checkbox"/> Fiber <input checked="" type="checkbox"/> Foam <input type="checkbox"/> Feather/Fiber Mix <input type="checkbox"/> Feather		
	<b>COMFORT</b>	Standard Comfort <input checked="" type="checkbox"/>	Firm Comfort <input checked="" type="checkbox"/>			
	<b>FUNCTION</b>	Bed <input type="checkbox"/>	Electric motion <input type="checkbox"/>	Motion <input type="checkbox"/>	Recliner <input type="checkbox"/>	Sliding <input type="checkbox"/>
	<b>OPTIONS</b>	Nails <input type="checkbox"/>	Removable <input type="checkbox"/>	Contrast Stitching <input type="checkbox"/>		

## NOTES

- Model available with accents fabric Retrò.
- Tight Seat Cushion (the seat cushions of the models are fixed to the frame)
- Tight Back Cushion (the back cushions of the models are fixed to the frame)
- Wood Frame
- Without Feet Assembled (the feet will be in a bag inside the package)
- Plastic Wrap (the model will be wrapped in a plastic bag)
- Front feet are slightly higher in respect to rear.
- Feet available in wood finishings 09 (Walnut) / 18 (Wengè) / 27 (Glossy Black)
- Feet height 10,5/3,5 cm
- Feet finishing 27 is available only in mix cat. 9K.
- LEATHER-FABRIC MIX COVERING OPTIONS available only for cat 9K:
- 1° COV. (Fabric) = Chair
- 2° COV. (Leather) = Welt (always 40BM Siena black)

NOTES

---



■ vers. 009



■ vers. 446



■ vers. 450 + 001 + 032 + 001 + 001 + 049



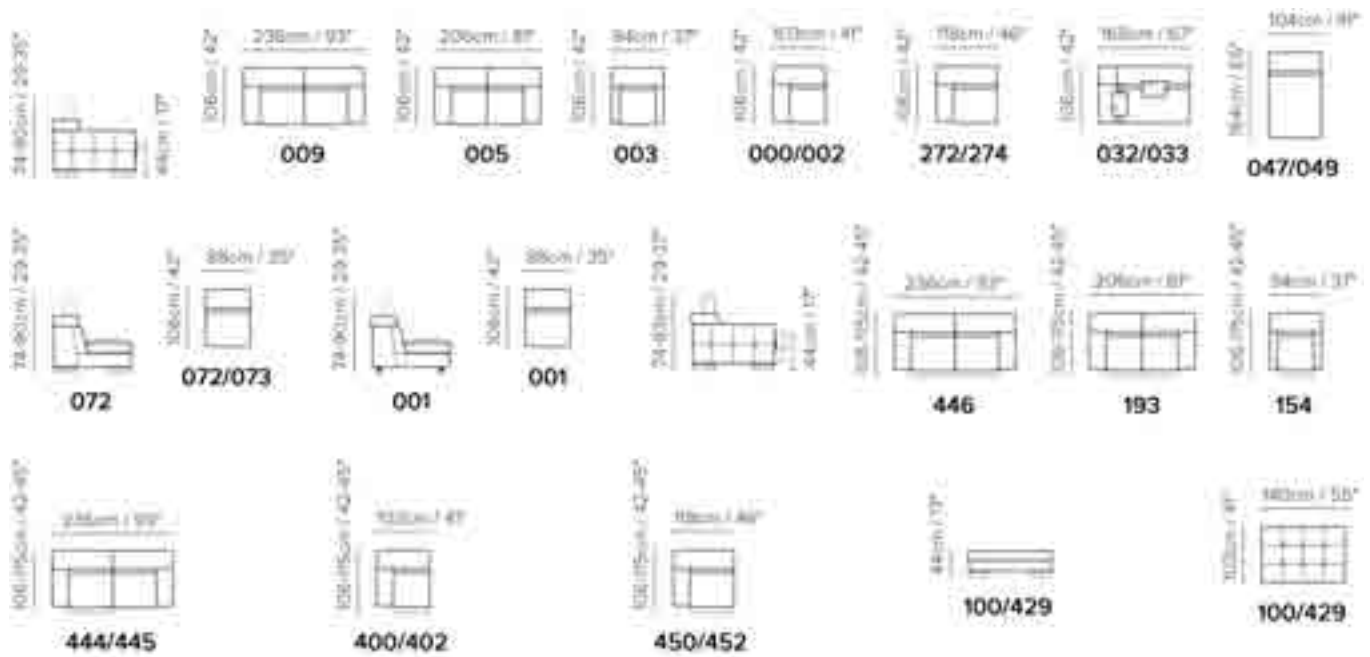



## SCHEMATICS



## COMPOSITION EXAMPLES



## TECHNICAL INFORMATION

	<b>COVERING</b>	Leather <input checked="" type="checkbox"/>				
	<b>LEGS</b>	Wood <input checked="" type="checkbox"/>	Metal <input type="checkbox"/>	Plastic <input type="checkbox"/>	Castors <input type="checkbox"/>	Upholstered <input type="checkbox"/>
	<b>FILLING</b>	Arms <input type="checkbox"/> Fiber <input checked="" type="checkbox"/> Foam <input type="checkbox"/> Feather/Fiber Mix <input type="checkbox"/> Feather	Seat cushion <input type="checkbox"/> Fiber <input checked="" type="checkbox"/> Foam <input checked="" type="checkbox"/> Feather/Fiber Mix <input type="checkbox"/> Feather	Back cushion <input type="checkbox"/> Fiber <input checked="" type="checkbox"/> Foam <input checked="" type="checkbox"/> Feather/Fiber Mix <input type="checkbox"/> Feather		
	<b>COMFORT</b>	Standard Comfort <input checked="" type="checkbox"/>	Firm Comfort <input type="checkbox"/>			
	<b>FUNCTION</b>	Bed <input type="checkbox"/>	Electric motion <input checked="" type="checkbox"/>	Motion <input type="checkbox"/>	Recliner <input checked="" type="checkbox"/>	Sliding <input type="checkbox"/>
	<b>OPTIONS</b>	Contrast Stitching <input type="checkbox"/>	Removable <input type="checkbox"/>	Nails <input type="checkbox"/>		

## NOTES

- Adjustable headrest on all versions.
- Tight Seat Cushion (the seat cushions of the models are fixed to the frame)
- Tight Back Cushion (the back cushions of the models are fixed to the frame)
- Wood Frame
- Without Feet Assembled (the feet will be in a bag inside the package)
- Plastic Wrap (the model will be wrapped in a plastic bag)
- Feet available in wood finishings 09 (Walnut) / 18 (Wengè) / ZM (Makassar; with upcharge)
- Feet height 5,5 cm
- Versions 047/049 are without arms.
- 2 and 3 seater versions are composed of two elements to be assembled.
- Versions 032/033 include 2 small cushions.
- Versions 450/452 and 400/402 do not have laterals upholstered in leather
- Versions 272/274-000/002-001-032/033-072/073-047/049 have laterals upholstered in leather.

NOTES

---





■ vers. 003



■ vers. 003







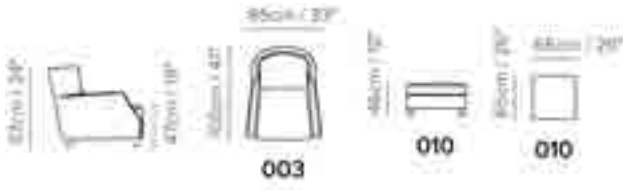

■ vers. 010

## SCHEMATICS

---



## TECHNICAL INFORMATION

	<b>COVERING</b>	Leather <input checked="" type="checkbox"/>				
	<b>LEGS</b>	Wood <input checked="" type="checkbox"/>	Metal <input type="checkbox"/>	Plastic <input type="checkbox"/>	Castors <input type="checkbox"/>	Upholstered <input type="checkbox"/>
	<b>FILLING</b>	Arms <input type="checkbox"/> Fiber <input checked="" type="checkbox"/> Foam <input type="checkbox"/> Feather/Fiber Mix <input type="checkbox"/> Feather	Seat cushion <input type="checkbox"/> Fiber <input checked="" type="checkbox"/> Foam <input type="checkbox"/> Feather/Fiber Mix <input checked="" type="checkbox"/> Feather	Back cushion <input type="checkbox"/> Fiber <input type="checkbox"/> Foam <input type="checkbox"/> Feather/Fiber Mix <input checked="" type="checkbox"/> Feather		
	<b>COMFORT</b>	Standard Comfort <input checked="" type="checkbox"/>	Firm Comfort <input type="checkbox"/>			
	<b>FUNCTION</b>	Bed <input type="checkbox"/>	Electric motion <input type="checkbox"/>	Motion <input type="checkbox"/>	Recliner <input type="checkbox"/>	Sliding <input type="checkbox"/>
	<b>OPTIONS</b>	Nails <input type="checkbox"/>	Removable <input type="checkbox"/>	Contrast Stitching <input type="checkbox"/>		

## NOTES

- Model is available with contrast welt to be entered as second covering
- Loose Seat Cushion (the seat cushions of the model are not fixed to the frame)
- Back Cushion Zippered (the back cushion is attached to the frame through a zipper)
- Wood Frame
- Without Feet Assembled (the feet will be in a bag inside the package)
- Plastic Wrap (the model will be wrapped in a plastic bag)
- Front feet are slightly higher in respect to rear.
- Feet available in wood finishings 09 (Walnut) / 18 (Wengè) / ZM (Makassar) all with glazed nickel base 75
- Feet height 10,0/8,5 cm

NOTES

---



■ vers. 003



■ vers. 003









■ vers. 003

## SCHEMATICS

---



## TECHNICAL INFORMATION

	<b>COVERING</b>	Mix <input checked="" type="checkbox"/>	Leather <input checked="" type="checkbox"/>	Soft Cover <input checked="" type="checkbox"/>		
	<b>LEGS</b>	Wood <input type="checkbox"/>	Metal <input checked="" type="checkbox"/>	Plastic <input type="checkbox"/>	Castors <input type="checkbox"/>	Upholstered <input type="checkbox"/>
	<b>FILLING</b>	Arms <input type="checkbox"/> Fiber <input checked="" type="checkbox"/> Foam <input type="checkbox"/> Feather/Fiber Mix <input type="checkbox"/> Feather	Seat cushion <input type="checkbox"/> Fiber <input checked="" type="checkbox"/> Foam <input type="checkbox"/> Feather/Fiber Mix <input type="checkbox"/> Feather	Back cushion <input type="checkbox"/> Fiber <input checked="" type="checkbox"/> Foam <input type="checkbox"/> Feather/Fiber Mix <input type="checkbox"/> Feather		
	<b>COMFORT</b>	Standard Comfort <input checked="" type="checkbox"/>	Firm Comfort <input type="checkbox"/>			
	<b>FUNCTION</b>	Bed <input type="checkbox"/>	Electric motion <input type="checkbox"/>	Motion <input type="checkbox"/>	Recliner <input type="checkbox"/>	Sliding <input type="checkbox"/>
	<b>OPTIONS</b>	Contrast Stitching <input type="checkbox"/>	Removable <input type="checkbox"/>	Nails <input type="checkbox"/>		

## NOTES

- Tight Seat Cushion (the seat cushions of the models are fixed to the frame)
- Tight Back Cushion (the back cushions of the models are fixed to the frame)
- Wood Frame
- With Feet Assembled (the model will be loaded with feet already mounted on the sofa)
- Front feet are slightly higher in respect to rear.
- Feet available in metal finishings 75 (Glazed Nickel) / 77 (Glossy Chromed)
- Feet height 10,0/2,5 cm
- LEATHER-FABRIC MIX COVERING OPTIONS:
- 1° COV. (Leather) = Outer body
- 2° COV. (Fabric) = Inner body and seat cushion

NOTES

---





■ vers. 009



■ vers. 018 + 049 + 246



■ vers. 200 + 017



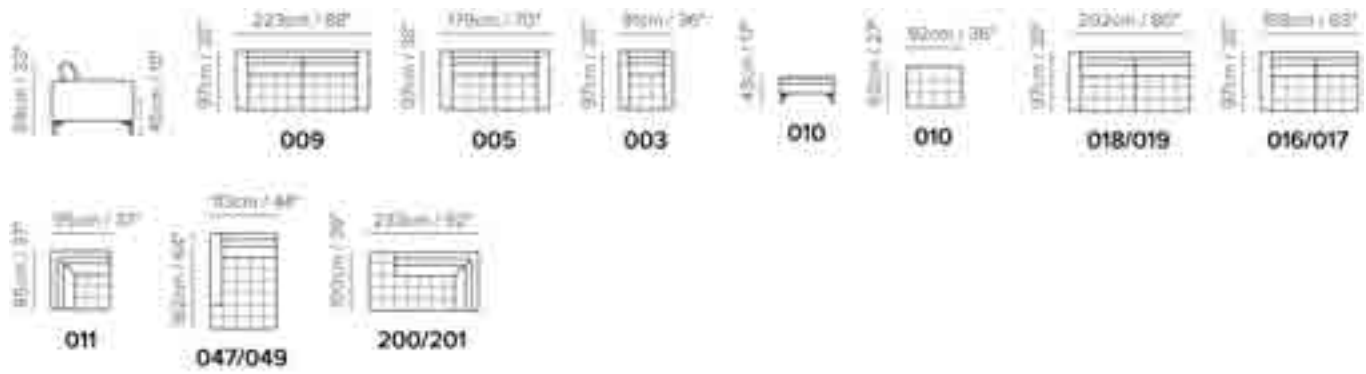

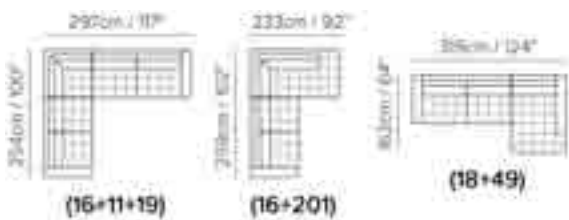

## SCHEMATICS



## COMPOSITION EXAMPLES



## TECHNICAL INFORMATION

	<b>COVERING</b>	Leather <input checked="" type="checkbox"/>	Soft Cover <input checked="" type="checkbox"/>			
	<b>LEGS</b>	Wood <input type="checkbox"/>	Metal <input checked="" type="checkbox"/>	Plastic <input type="checkbox"/>	Castors <input type="checkbox"/>	Upholstered <input type="checkbox"/>
	<b>FILLING</b>	Arms <input type="checkbox"/> Fiber <input checked="" type="checkbox"/> Foam <input type="checkbox"/> Feather/Fiber Mix <input type="checkbox"/> Feather	Seat cushion <input type="checkbox"/> Fiber <input checked="" type="checkbox"/> Foam <input type="checkbox"/> Feather/Fiber Mix <input type="checkbox"/> Feather	Back cushion <input type="checkbox"/> Fiber <input checked="" type="checkbox"/> Foam <input type="checkbox"/> Feather/Fiber Mix <input type="checkbox"/> Feather		
	<b>COMFORT</b>	Standard Comfort <input checked="" type="checkbox"/>	Firm Comfort <input checked="" type="checkbox"/>			
	<b>FUNCTION</b>	Bed <input type="checkbox"/>	Electric motion <input type="checkbox"/>	Motion <input type="checkbox"/>	Recliner <input type="checkbox"/>	Sliding <input type="checkbox"/>
	<b>OPTIONS</b>	Nails <input type="checkbox"/>	Removable <input type="checkbox"/>	Contrast Stitching <input type="checkbox"/>		

## NOTES

- Tight Seat Cushion (the seat cushions of the models are fixed to the frame)
- No Leather Side (the sectional pieces have the side covered with fabric and not leather)
- Wood Frame
- Without Feet Assembled (the feet will be in a bag inside the package)
- Plastic Wrap (the model will be wrapped in a plastic bag)
- Feet available in metal finishings 75 (Glazed Nickel) / 77 (Glossy Chromed)
- Feet height 15,0 cm
- Model is available without tufted seat when ordered as V458

NOTES

---



■ vers. 018 + 019



■ vers. 016 + 463 + 017



■ vers. 212 + 438 + 438 + 016 + 001 + 463



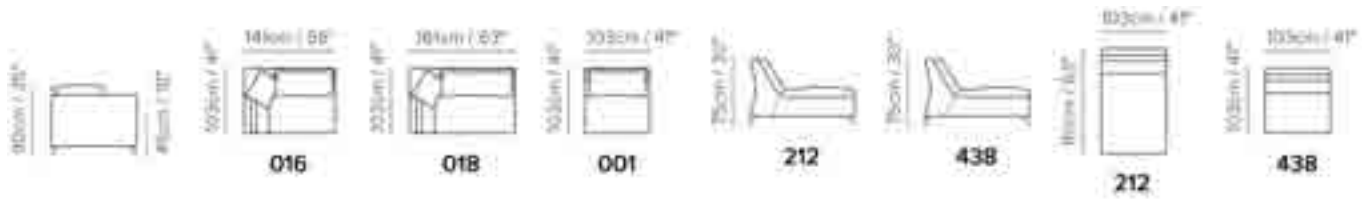

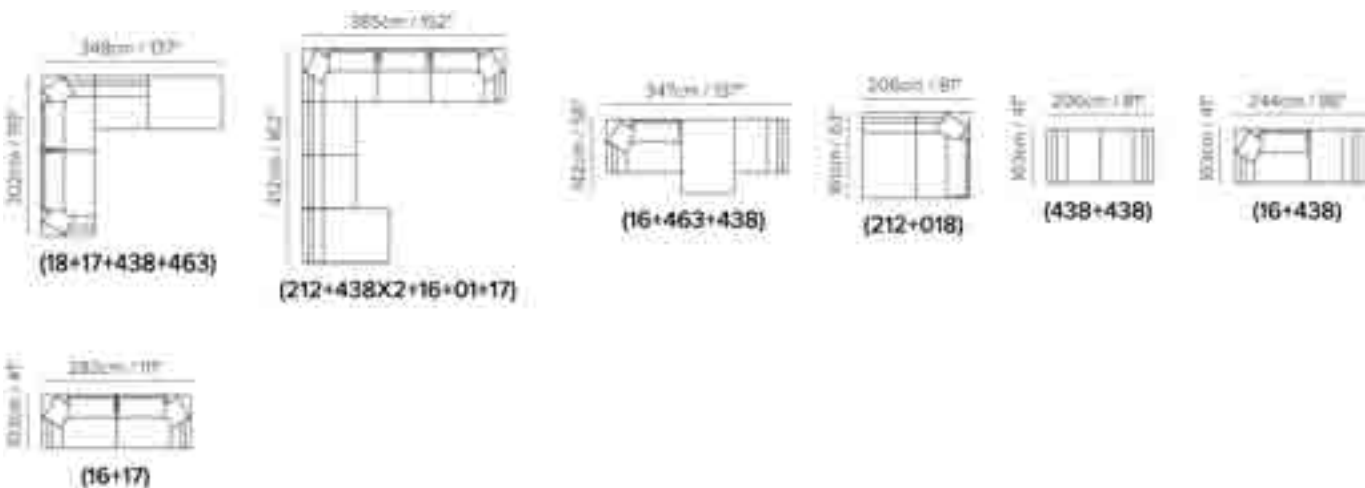

## SCHEMATICS



## COMPOSITION EXAMPLES



## TECHNICAL INFORMATION

	<b>COVERING</b>	Mix <input checked="" type="checkbox"/>	Leather <input checked="" type="checkbox"/>	Soft Cover <input checked="" type="checkbox"/>		
	<b>LEGS</b>	Wood <input type="checkbox"/>	Metal <input checked="" type="checkbox"/>	Plastic <input type="checkbox"/>	Castors <input type="checkbox"/>	Upholstered <input type="checkbox"/>
	<b>FILLING</b>	Arms <input type="checkbox"/> Fiber <input checked="" type="checkbox"/> Foam <input checked="" type="checkbox"/> Feather/Fiber Mix <input type="checkbox"/> Feather	Seat cushion <input type="checkbox"/> Fiber <input checked="" type="checkbox"/> Foam <input checked="" type="checkbox"/> Feather/Fiber Mix <input type="checkbox"/> Feather	Back cushion <input type="checkbox"/> Fiber <input checked="" type="checkbox"/> Foam <input checked="" type="checkbox"/> Feather/Fiber Mix <input type="checkbox"/> Feather		
	<b>COMFORT</b>	Standard Comfort <input checked="" type="checkbox"/>	Firm Comfort <input type="checkbox"/>			
	<b>FUNCTION</b>	Bed <input type="checkbox"/>	Electric motion <input type="checkbox"/>	Motion <input type="checkbox"/>	Recliner <input type="checkbox"/>	Sliding <input type="checkbox"/>
	<b>OPTIONS</b>	Contrast Stitching <input type="checkbox"/>	Removable <input type="checkbox"/>	Nails <input type="checkbox"/>		

## NOTES

- Seat cushion zippered (the seat cushion is attached to the frame through a zipper)
- Arm Cushion Zippered (the arm cushion is attached to the frame through a zipper)
- Wood Frame
- Without Feet Assembled (the feet will be in a bag inside the package)
- Plastic Wrap (the model will be wrapped in a plastic bag)
- Feet available in metal finishings 75 (Glazed Nickel) / 77 (Glossy Chromed)
- Feet height 12,0 cm
- Version 001 includes 1 back cushion.
- Version 016/017/018/019 include 1 back cushion and 1 small cushion.
- Closed back panel on versions 212/438
- LEATHER-FABRIC MIX COVERING OPTIONS:
- 1° COV. (Leather) = Frame
- 2° COV. (Fabric) = Arms and seat cushions
- 3° COV. (Fabric) = Back cushions
- 4° COV. (Fabric) = Small cushions
- TWO TONE COVERING OPTIONS IN FABRIC:
- 1° COV. = Frame
- 2° COV. = Seat cushions and arms
- 3° COV. = Back cushions

### NOTES

---

- 4° COV. = Small cushions





■ vers. 244



■ vers. 244









■ vers. 244

## SCHEMATICS

---



## TECHNICAL INFORMATION

	<b>COVERING</b>	Leather <input checked="" type="checkbox"/>	Soft Cover <input checked="" type="checkbox"/>			
	<b>LEGS</b>	Wood <input type="checkbox"/>	Metal <input checked="" type="checkbox"/>	Plastic <input type="checkbox"/>	Castors <input type="checkbox"/>	Upholstered <input type="checkbox"/>
	<b>FILLING</b>	Arms <input type="checkbox"/> Fiber <input checked="" type="checkbox"/> Foam <input type="checkbox"/> Feather/Fiber Mix <input type="checkbox"/> Feather	Seat cushion <input type="checkbox"/> Fiber <input checked="" type="checkbox"/> Foam <input type="checkbox"/> Feather/Fiber Mix <input type="checkbox"/> Feather	Back cushion <input type="checkbox"/> Fiber <input checked="" type="checkbox"/> Foam <input type="checkbox"/> Feather/Fiber Mix <input type="checkbox"/> Feather		
	<b>COMFORT</b>	Standard Comfort <input checked="" type="checkbox"/>	Firm Comfort <input checked="" type="checkbox"/>			
	<b>FUNCTION</b>	Bed <input type="checkbox"/>	Electric motion <input type="checkbox"/>	Motion <input type="checkbox"/>	Recliner <input checked="" type="checkbox"/>	Sliding <input type="checkbox"/>
	<b>OPTIONS</b>	Nails <input type="checkbox"/>	Removable <input type="checkbox"/>	Contrast Stitching <input type="checkbox"/>		

## NOTES

- Tight Seat Cushion (the seat cushions of the models are fixed to the frame)
- Tight Back Cushion (the back cushions of the models are fixed to the frame)
- Wood Frame
- Without Feet Assembled (the feet will be in a bag inside the package)
- Metal base available in finishing 75 (Glazed Nickel)

NOTES

---



■ vers. 004



■ vers. 004







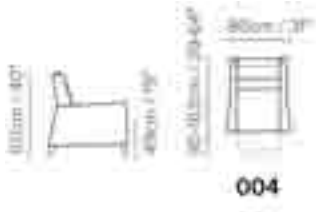

■ vers. 004

## SCHEMATICS

---



## TECHNICAL INFORMATION

	<b>COVERING</b>	Leather <input checked="" type="checkbox"/>	Soft Cover <input checked="" type="checkbox"/>			
	<b>LEGS</b>	Wood <input checked="" type="checkbox"/>	Metal <input type="checkbox"/>	Plastic <input type="checkbox"/>	Castors <input type="checkbox"/>	Upholstered <input type="checkbox"/>
	<b>FILLING</b>	Arms <input type="checkbox"/> Fiber <input checked="" type="checkbox"/> Foam <input type="checkbox"/> Feather/Fiber Mix <input type="checkbox"/> Feather	Seat cushion <input type="checkbox"/> Fiber <input checked="" type="checkbox"/> Foam <input type="checkbox"/> Feather/Fiber Mix <input type="checkbox"/> Feather	Back cushion <input type="checkbox"/> Fiber <input checked="" type="checkbox"/> Foam <input type="checkbox"/> Feather/Fiber Mix <input type="checkbox"/> Feather		
	<b>COMFORT</b>	Standard Comfort <input checked="" type="checkbox"/>	Firm Comfort <input checked="" type="checkbox"/>			
	<b>FUNCTION</b>	Bed <input type="checkbox"/>	Electric motion <input type="checkbox"/>	Motion <input type="checkbox"/>	Recliner <input checked="" type="checkbox"/>	Sliding <input type="checkbox"/>
	<b>OPTIONS</b>	Contrast Stitching <input type="checkbox"/>	Removable <input type="checkbox"/>	Nails <input type="checkbox"/>		

## NOTES

- Tight Back Cushion (the back cushions of the models are fixed to the frame)
- Tight Seat Cushion (the seat cushions of the models are fixed to the frame)
- Wood Frame
- Without Feet Assembled (the feet will be in a bag inside the package)
- Plastic Wrap (the model will be wrapped in a plastic bag)
- Front feet are slightly higher in respect to rear.
- Feet available in wood finishings 09 (Walnut) / 18 (Wengè) / ZM (Makassar; with upcharge)
- Feet height 13,5/11,0 cm

NOTES

---





■ vers. 009



■ vers. 009



■ vers. 146



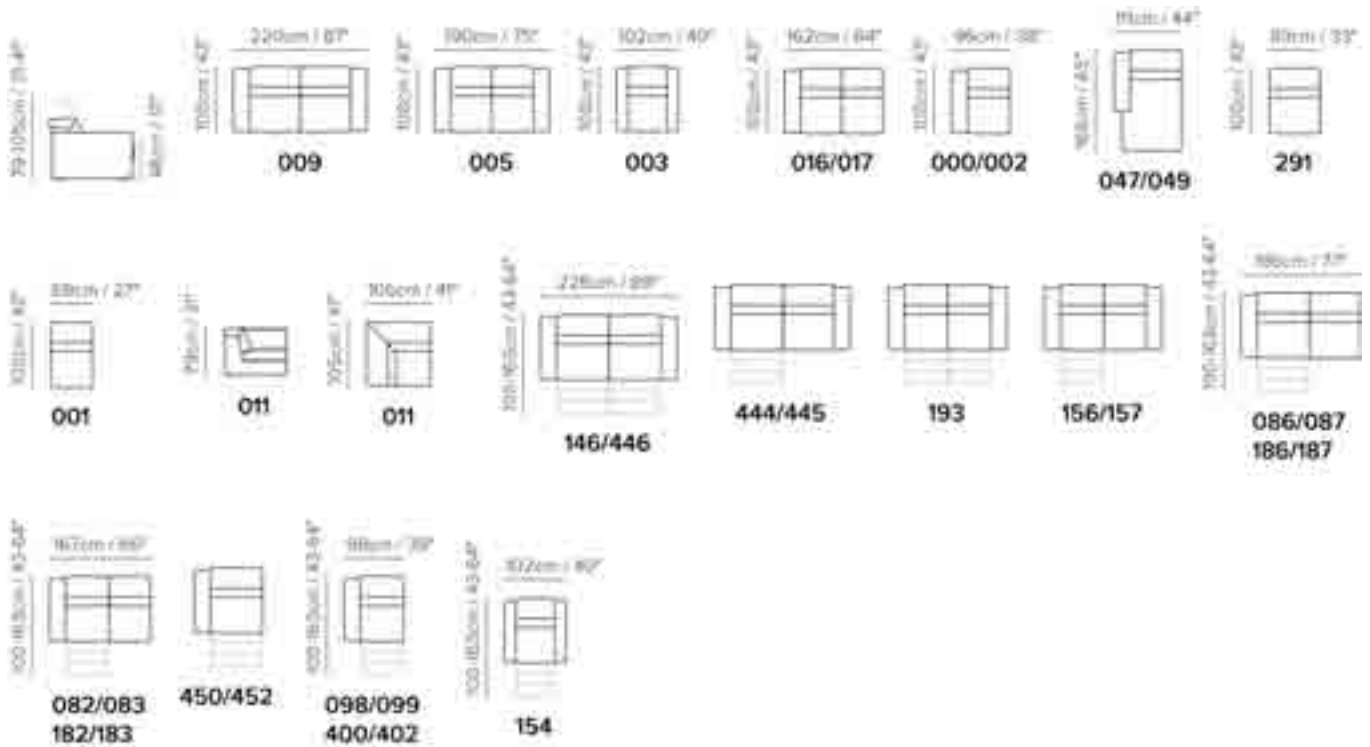

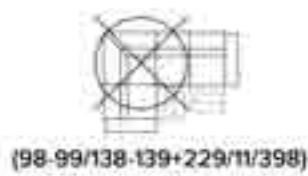
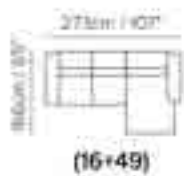

## SCHEMATICS



## COMPOSITION EXAMPLES



## TECHNICAL INFORMATION

	<b>COVERING</b>	Leather <input checked="" type="checkbox"/>	Soft Cover <input checked="" type="checkbox"/>			
	<b>LEGS</b>	Wood <input checked="" type="checkbox"/>	Metal <input type="checkbox"/>	Plastic <input type="checkbox"/>	Castors <input type="checkbox"/>	Upholstered <input type="checkbox"/>
	<b>FILLING</b>	Arms <input type="checkbox"/> Fiber <input checked="" type="checkbox"/> Foam <input type="checkbox"/> Feather/Fiber Mix <input type="checkbox"/> Feather	Seat cushion <input type="checkbox"/> Fiber <input checked="" type="checkbox"/> Foam <input type="checkbox"/> Feather/Fiber Mix <input type="checkbox"/> Feather	Back cushion <input type="checkbox"/> Fiber <input checked="" type="checkbox"/> Foam <input type="checkbox"/> Feather/Fiber Mix <input type="checkbox"/> Feather		
	<b>COMFORT</b>	Standard Comfort <input checked="" type="checkbox"/>	Firm Comfort <input checked="" type="checkbox"/>			
	<b>FUNCTION</b>	Bed <input type="checkbox"/>	Electric motion <input checked="" type="checkbox"/>	Motion <input checked="" type="checkbox"/>	Recliner <input checked="" type="checkbox"/>	Sliding <input type="checkbox"/>
	<b>OPTIONS</b>	Nails <input type="checkbox"/>	Removable <input type="checkbox"/>	Contrast Stitching <input type="checkbox"/>		

## NOTES

- Model is available with contrast welt to be entered as second covering
- Stitching on model is based on the color of the welt; even on versions without welt (i.e. pouf, corner, armless chair) the second covering needs to be entered in Nares so that the stitching will be the same as the rest of the sofa.
- Adjustable headrest on all versions except the corners.
- Tight Seat Cushion (the seat cushions of the models are fixed to the frame)
- Tight Back Cushion (the back cushions of the models are fixed to the frame)
- No Leather Side (the sectional pieces have the side covered with fabric and not leather)
- Wood Frame
- Without Feet Assembled (the feet will be in a bag inside the package)
- Plastic Wrap (the model will be wrapped in a plastic bag)
- Feet available in wood finishings 09 (Walnut) / 18 (Wengè)
- Feet height 3,0 cm
- Model is available for leather only with contrast welt.
- TWO TONE COVERING OPTIONS IN FABRIC:
  - 1° COV. = Frame and arms
  - 2° COV. = Headrest, seat and back cushions

NOTES

---



■ vers. 066



■ vers. 066









■ vers. 066 + 207

## SCHEMATICS

---



## TECHNICAL INFORMATION

	<b>COVERING</b>	Leather <input checked="" type="checkbox"/>	Soft Cover <input checked="" type="checkbox"/>			
	<b>LEGS</b>	Wood <input type="checkbox"/>	Metal <input checked="" type="checkbox"/>	Plastic <input type="checkbox"/>	Castors <input type="checkbox"/>	Upholstered <input type="checkbox"/>
	<b>FILLING</b>	Arms <input type="checkbox"/> Fiber <input checked="" type="checkbox"/> Foam <input type="checkbox"/> Feather/Fiber Mix <input type="checkbox"/> Feather	Seat cushion <input type="checkbox"/> Fiber <input checked="" type="checkbox"/> Foam <input type="checkbox"/> Feather/Fiber Mix <input type="checkbox"/> Feather	Back cushion <input type="checkbox"/> Fiber <input checked="" type="checkbox"/> Foam <input checked="" type="checkbox"/> Feather/Fiber Mix <input type="checkbox"/> Feather		
	<b>COMFORT</b>	Standard Comfort <input checked="" type="checkbox"/>	Firm Comfort <input type="checkbox"/>			
	<b>FUNCTION</b>	Bed <input type="checkbox"/>	Electric motion <input type="checkbox"/>	Motion <input type="checkbox"/>	Recliner <input type="checkbox"/>	Sliding <input type="checkbox"/>
	<b>OPTIONS</b>	Contrast Stitching <input type="checkbox"/>	Removable <input type="checkbox"/>	Nails <input type="checkbox"/>		

## NOTES

- Version 066 includes audio kit.
- Vers. 003 has swivel base and is without speakers.
- Tight Seat Cushion (the seat cushions of the models are fixed to the frame)
- Tight Back Cushion (the back cushions of the models are fixed to the frame)
- Metal Frame
- With Feet Assembled (the model will be loaded with feet already mounted on the sofa)
- Metal base available in finishing 75 (Glazed Nickel)

NOTES

---





■ vers. 018 + 029 + 019



■ vers. 018 + 029 + 019



■ vers. 018 + 029 + 002



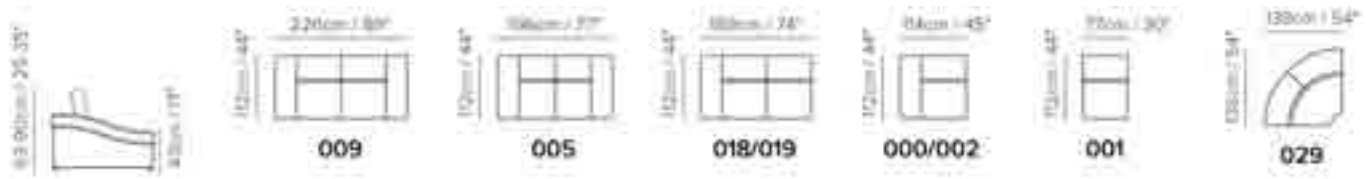



## SCHEMATICS



## COMPOSITION EXAMPLES



## TECHNICAL INFORMATION

	<b>COVERING</b>	Leather <input checked="" type="checkbox"/>				
	<b>LEGS</b>	Wood <input checked="" type="checkbox"/>	Metal <input type="checkbox"/>	Plastic <input type="checkbox"/>	Castors <input type="checkbox"/>	Upholstered <input type="checkbox"/>
	<b>FILLING</b>	Arms <input type="checkbox"/> Fiber <input checked="" type="checkbox"/> Foam <input type="checkbox"/> Feather/Fiber Mix <input type="checkbox"/> Feather	Seat cushion <input type="checkbox"/> Fiber <input checked="" type="checkbox"/> Foam <input type="checkbox"/> Feather/Fiber Mix <input type="checkbox"/> Feather	Back cushion <input type="checkbox"/> Fiber <input checked="" type="checkbox"/> Foam <input type="checkbox"/> Feather/Fiber Mix <input type="checkbox"/> Feather		
	<b>COMFORT</b>	Standard Comfort <input checked="" type="checkbox"/>	Firm Comfort <input type="checkbox"/>			
	<b>FUNCTION</b>	Bed <input type="checkbox"/>	Electric motion <input type="checkbox"/>	Motion <input type="checkbox"/>	Recliner <input type="checkbox"/>	Sliding <input type="checkbox"/>
	<b>OPTIONS</b>	Nails <input type="checkbox"/>	Removable <input type="checkbox"/>	Contrast Stitching <input type="checkbox"/>		

## NOTES

- Adjustable headrest on all versions except the corners.
- Tight Seat Cushion (the seat cushions of the models are fixed to the frame)
- Tight Back Cushion (the back cushions of the models are fixed to the frame)
- No Leather Side (the sectional pieces have the side covered with fabric and not leather)
- Wood Frame
- Without Feet Assembled (the feet will be in a bag inside the package)
- Plastic Wrap (the model will be wrapped in a plastic bag)
- Feet available in wood finishings 09 (Walnut) / 18 (Wengè)
- Feet height 4,0 cm

NOTES

---



■ vers. 239



■ vers. 239









■ vers. 233

## SCHEMATICS

---



## TECHNICAL INFORMATION

	<b>COVERING</b>	Leather <input checked="" type="checkbox"/>	Soft Cover <input checked="" type="checkbox"/>			
	<b>LEGS</b>	Wood <input type="checkbox"/>	Metal <input checked="" type="checkbox"/>	Plastic <input type="checkbox"/>	Castors <input type="checkbox"/>	Upholstered <input type="checkbox"/>
	<b>FILLING</b>	Arms <input type="checkbox"/> Fiber <input checked="" type="checkbox"/> Foam <input type="checkbox"/> Feather/Fiber Mix <input type="checkbox"/> Feather	Seat cushion <input type="checkbox"/> Fiber <input checked="" type="checkbox"/> Foam <input type="checkbox"/> Feather/Fiber Mix <input type="checkbox"/> Feather	Back cushion <input type="checkbox"/> Fiber <input checked="" type="checkbox"/> Foam <input type="checkbox"/> Feather/Fiber Mix <input type="checkbox"/> Feather		
	<b>COMFORT</b>	Standard Comfort <input checked="" type="checkbox"/>	Firm Comfort <input checked="" type="checkbox"/>			
	<b>FUNCTION</b>	Bed <input type="checkbox"/>	Electric motion <input type="checkbox"/>	Motion <input type="checkbox"/>	Recliner <input type="checkbox"/>	Sliding <input type="checkbox"/>
	<b>OPTIONS</b>	Contrast Stitching <input type="checkbox"/>	Removable <input type="checkbox"/>	Nails <input type="checkbox"/>		

## NOTES

- Tight Seat Cushion (the seat cushions of the models are fixed to the frame)
- Wood Frame
- Plastic Wrap (the model will be wrapped in a plastic bag)
- Without Feet Assembled (the feet will be in a bag inside the package)
- Metal base available in finishing 75 (Glazed Nickel)
- Feet height 14,0 cm
- Model available only with second option versions.
- TWO TONE COVERING OPTIONS IN FABRIC:
- 1° COV. = Frame, arms and seat cushions
- 2° COV. = Back cushions

NOTES

---





■ vers. 146 + 2x 113



■ vers. 146 + 2x 113







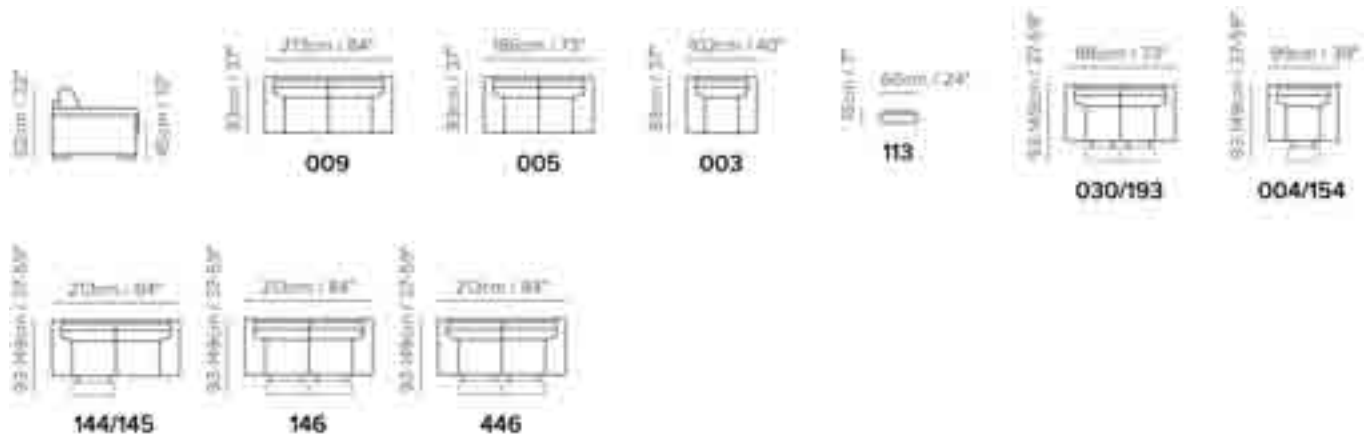

■ vers. 082 + 221 + 113

## SCHEMATICS



## COMPOSITION EXAMPLES

## TECHNICAL INFORMATION

	<b>COVERING</b>	Leather <input checked="" type="checkbox"/>	Soft Cover <input checked="" type="checkbox"/>			
	<b>LEGS</b>	Wood <input checked="" type="checkbox"/>	Metal <input type="checkbox"/>	Plastic <input type="checkbox"/>	Castors <input type="checkbox"/>	Upholstered <input type="checkbox"/>
	<b>FILLING</b>	Arms <input type="checkbox"/> Fiber <input checked="" type="checkbox"/> Foam <input type="checkbox"/> Feather/Fiber Mix <input type="checkbox"/> Feather	Seat cushion <input type="checkbox"/> Fiber <input checked="" type="checkbox"/> Foam <input type="checkbox"/> Feather/Fiber Mix <input type="checkbox"/> Feather	Back cushion <input type="checkbox"/> Fiber <input checked="" type="checkbox"/> Foam <input type="checkbox"/> Feather/Fiber Mix <input type="checkbox"/> Feather		
	<b>COMFORT</b>	Standard Comfort <input checked="" type="checkbox"/>	Firm Comfort <input checked="" type="checkbox"/>			
	<b>FUNCTION</b>	Bed <input type="checkbox"/>	Electric motion <input checked="" type="checkbox"/>	Motion <input checked="" type="checkbox"/>	Recliner <input checked="" type="checkbox"/>	Sliding <input type="checkbox"/>
	<b>OPTIONS</b>	Nails <input type="checkbox"/>	Removable <input type="checkbox"/>	Contrast Stitching <input type="checkbox"/>		

## NOTES

- Tight Back Cushion (the back cushions of the models are fixed to the frame)
- Tight Seat Cushion (the seat cushions of the models are fixed to the frame)
- No Leather Side (the sectional pieces have the side covered with fabric and not leather)
- Wood Frame
- Plastic Wrap (the model will be wrapped in a plastic bag)
- Without Feet Assembled (the feet will be in a bag inside the package)
- Feet available in wood finishings 09 (Walnut) / 18 (Wengè)
- Feet height 4,5 cm

NOTES

---



■ vers. 239



■ vers. 277 + 287



■ vers. 277 + 287

## SCHEMATICS

---

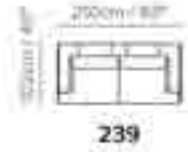





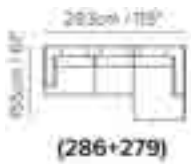

## COMPOSITION EXAMPLES

---



## TECHNICAL INFORMATION

	<b>COVERING</b>	Leather <input checked="" type="checkbox"/>	Soft Cover <input checked="" type="checkbox"/>			
	<b>LEGS</b>	Wood <input type="checkbox"/>	Metal <input checked="" type="checkbox"/>	Plastic <input type="checkbox"/>	Castors <input type="checkbox"/>	Upholstered <input type="checkbox"/>
	<b>FILLING</b>	Arms <input type="checkbox"/> Fiber <input checked="" type="checkbox"/> Foam <input type="checkbox"/> Feather/Fiber Mix <input type="checkbox"/> Feather	Seat cushion <input type="checkbox"/> Fiber <input checked="" type="checkbox"/> Foam <input type="checkbox"/> Feather/Fiber Mix <input type="checkbox"/> Feather	Back cushion <input type="checkbox"/> Fiber <input checked="" type="checkbox"/> Foam <input type="checkbox"/> Feather/Fiber Mix <input type="checkbox"/> Feather		
	<b>COMFORT</b>	Standard Comfort <input checked="" type="checkbox"/>	Firm Comfort <input checked="" type="checkbox"/>			
	<b>FUNCTION</b>	Bed <input type="checkbox"/>	Electric motion <input type="checkbox"/>	Motion <input type="checkbox"/>	Recliner <input type="checkbox"/>	Sliding <input type="checkbox"/>
	<b>OPTIONS</b>	Contrast Stitching <input type="checkbox"/>	Removable <input type="checkbox"/>	Nails <input type="checkbox"/>		

## NOTES

- Adjustable back
- Tight Back Cushion (the back cushions of the models are fixed to the frame)
- Tight Seat Cushion (the seat cushions of the models are fixed to the frame)
- No Leather Side (the sectional pieces have the side covered with fabric and not leather)
- Wood Frame
- Without Feet Assembled (the feet will be in a bag inside the package)
- Feet available in metal finishing 75 (Glazed Nickel)
- Feet height 12,0 cm
- Model available only with second option versions.

NOTES

---





■ vers. 009



■ vers. 016 + 076 + 217



■ vers. 016 + 049



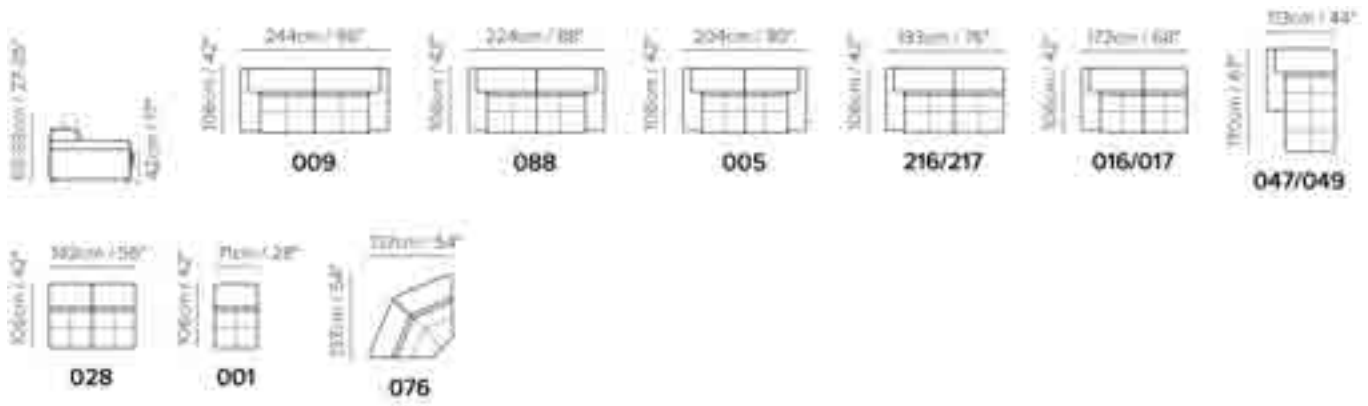

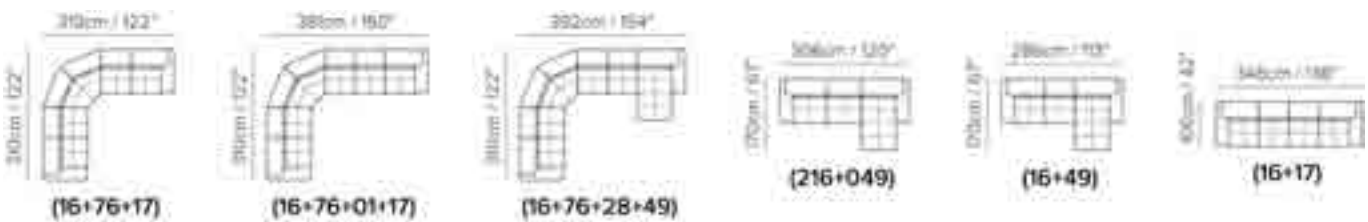

## SCHEMATICS



## COMPOSITION EXAMPLES



## TECHNICAL INFORMATION

	<b>COVERING</b>	Leather <input checked="" type="checkbox"/>				
	<b>LEGS</b>	Wood <input checked="" type="checkbox"/>	Metal <input type="checkbox"/>	Plastic <input type="checkbox"/>	Castors <input type="checkbox"/>	Upholstered <input type="checkbox"/>
	<b>FILLING</b>	Arms <input type="checkbox"/> Fiber <input checked="" type="checkbox"/> Foam <input type="checkbox"/> Feather/Fiber Mix <input type="checkbox"/> Feather	Seat cushion <input type="checkbox"/> Fiber <input checked="" type="checkbox"/> Foam <input type="checkbox"/> Feather/Fiber Mix <input type="checkbox"/> Feather	Back cushion <input type="checkbox"/> Fiber <input checked="" type="checkbox"/> Foam <input type="checkbox"/> Feather/Fiber Mix <input type="checkbox"/> Feather		
	<b>COMFORT</b>	Standard Comfort <input checked="" type="checkbox"/>	Firm Comfort <input type="checkbox"/>			
	<b>FUNCTION</b>	Bed <input type="checkbox"/>	Electric motion <input type="checkbox"/>	Motion <input type="checkbox"/>	Recliner <input type="checkbox"/>	Sliding <input type="checkbox"/>
	<b>OPTIONS</b>	Nails <input type="checkbox"/>	Removable <input type="checkbox"/>	Contrast Stitching <input type="checkbox"/>		

## NOTES

- Adjustable headrest on all versions except the corners.
- Tight Seat Cushion (the seat cushions of the models are fixed to the frame)
- Tight Back Cushion (the back cushions of the models are fixed to the frame)
- No Leather Side (the sectional pieces have the side covered with fabric and not leather)
- Wood Frame
- Without Feet Assembled (the feet will be in a bag inside the package)
- Plastic Wrap (the model will be wrapped in a plastic bag)
- Feet available in wood finishings 09 (Walnut) / 18 (Wengè)
- Feet height 4,5 cm
- Round arm and headrest kit are available in metal finishings 75 and 77.
- Model available with contrast stitching when ordered as V570.

NOTES

---



■ vers. 009



■ vers. 072 + 399 + 019



■ vers. 072 + 399 + 019



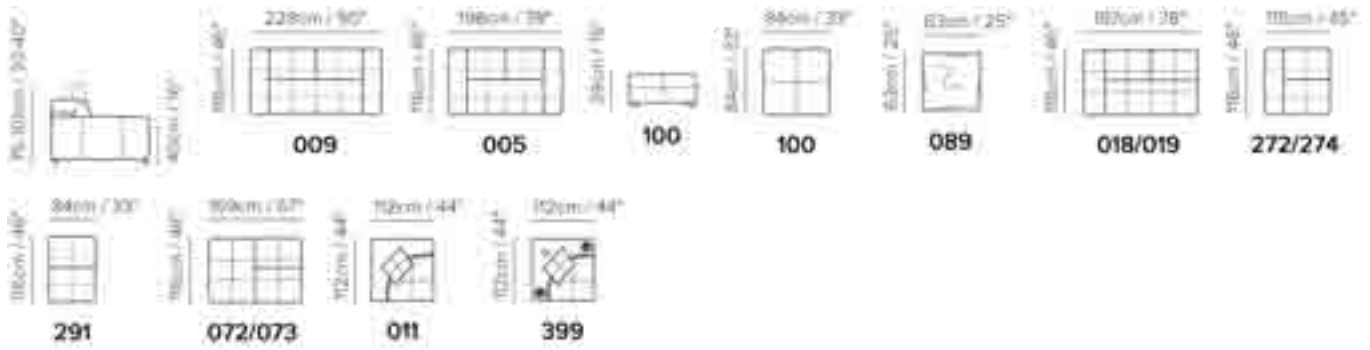



## SCHEMATICS



## COMPOSITION EXAMPLES



## TECHNICAL INFORMATION

	<b>COVERING</b>	Leather <input checked="" type="checkbox"/>				
	<b>LEGS</b>	Wood <input checked="" type="checkbox"/>	Metal <input type="checkbox"/>	Plastic <input checked="" type="checkbox"/>	Castors <input type="checkbox"/>	Upholstered <input type="checkbox"/>
	<b>FILLING</b>	Arms <input type="checkbox"/> Fiber <input checked="" type="checkbox"/> Foam <input type="checkbox"/> Feather/Fiber Mix <input type="checkbox"/> Feather	Seat cushion <input type="checkbox"/> Fiber <input checked="" type="checkbox"/> Foam <input type="checkbox"/> Feather/Fiber Mix <input type="checkbox"/> Feather	Back cushion <input type="checkbox"/> Fiber <input checked="" type="checkbox"/> Foam <input type="checkbox"/> Feather/Fiber Mix <input type="checkbox"/> Feather		
	<b>COMFORT</b>	Standard Comfort <input checked="" type="checkbox"/>	Firm Comfort <input type="checkbox"/>			
	<b>FUNCTION</b>	Bed <input type="checkbox"/>	Electric motion <input type="checkbox"/>	Motion <input type="checkbox"/>	Recliner <input type="checkbox"/>	Sliding <input type="checkbox"/>
	<b>OPTIONS</b>	Contrast Stitching <input type="checkbox"/>	Removable <input type="checkbox"/>	Nails <input type="checkbox"/>		

## NOTES

- Version 399 includes audio kit.
- Adjustable headrest on all versions.
- Tight Back Cushion (the back cushions of the models are fixed to the frame)
- Tight Seat Cushion (the seat cushions of the models are fixed to the frame)
- No Leather Side (the sectional pieces have the side covered with fabric and not leather)
- Wood Frame
- Plastic Wrap (the model will be wrapped in a plastic bag)
- Without Feet Assembled (the feet will be in a bag inside the package)
- Feet available in wood finishings 09 (Walnut) / 18 (Wengè)
- Feet height 4,5 cm
- Versions 011/399 include 1 small cushion.
- Model available with contrast stitching when ordered as V571.

NOTES

---





■ vers. 009



■ vers. 009 + 113



■ vers. 018 + 201



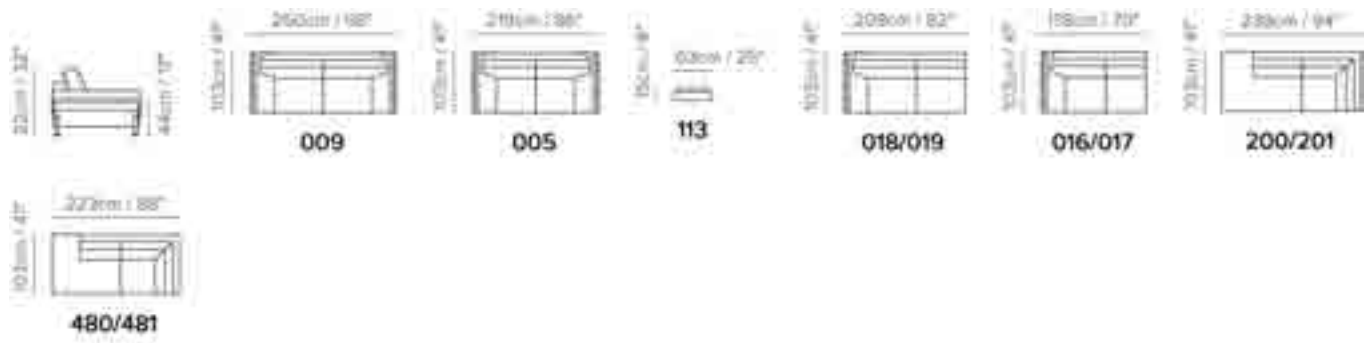

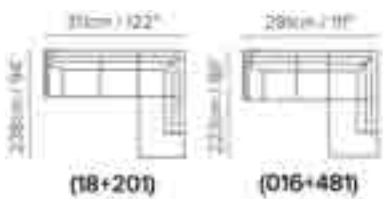

## SCHEMATICS



## COMPOSITION EXAMPLES



## TECHNICAL INFORMATION

	<b>COVERING</b>	Leather <input checked="" type="checkbox"/>	Soft Cover <input checked="" type="checkbox"/>			
	<b>LEGS</b>	Wood <input type="checkbox"/>	Metal <input checked="" type="checkbox"/>	Plastic <input type="checkbox"/>	Castors <input type="checkbox"/>	Upholstered <input type="checkbox"/>
	<b>FILLING</b>	Arms <input type="checkbox"/> Fiber <input checked="" type="checkbox"/> Foam <input type="checkbox"/> Feather/Fiber Mix <input type="checkbox"/> Feather	Seat cushion <input type="checkbox"/> Fiber <input checked="" type="checkbox"/> Foam <input type="checkbox"/> Feather/Fiber Mix <input type="checkbox"/> Feather	Back cushion <input type="checkbox"/> Fiber <input checked="" type="checkbox"/> Foam <input checked="" type="checkbox"/> Feather/Fiber Mix <input type="checkbox"/> Feather		
	<b>COMFORT</b>	Standard Comfort <input checked="" type="checkbox"/>	Firm Comfort <input type="checkbox"/>			
	<b>FUNCTION</b>	Bed <input type="checkbox"/>	Electric motion <input type="checkbox"/>	Motion <input type="checkbox"/>	Recliner <input type="checkbox"/>	Sliding <input type="checkbox"/>
	<b>OPTIONS</b>	Nails <input type="checkbox"/>	Removable <input type="checkbox"/>	Contrast Stitching <input type="checkbox"/>		

## NOTES

- Seat cushion includes a layer of memory foam, a pressure-sensitive soft polyurethane, that recovers its form completely thus giving great comfort
- Tight Seat Cushion (the seat cushions of the models are fixed to the frame)
- Back Cushion with elastic belt with buckle (the back cushion is attached to the frame through an elastic belt with buckle)
- No Leather Side (the sectional pieces have the side covered with fabric and not leather)
- Wood Frame
- Without Feet Assembled (the feet will be in a bag inside the package)
- Plastic Wrap (the model will be wrapped in a plastic bag)
- Feet available in metal finishing 75 (Glazed Nickel)
- Feet height 12,0 cm
- Versions 480/481 differ in dimensions from versions 200/201.

NOTES

---



■ vers. 009



■ vers. 086 + 049



■ vers. 086 + 221



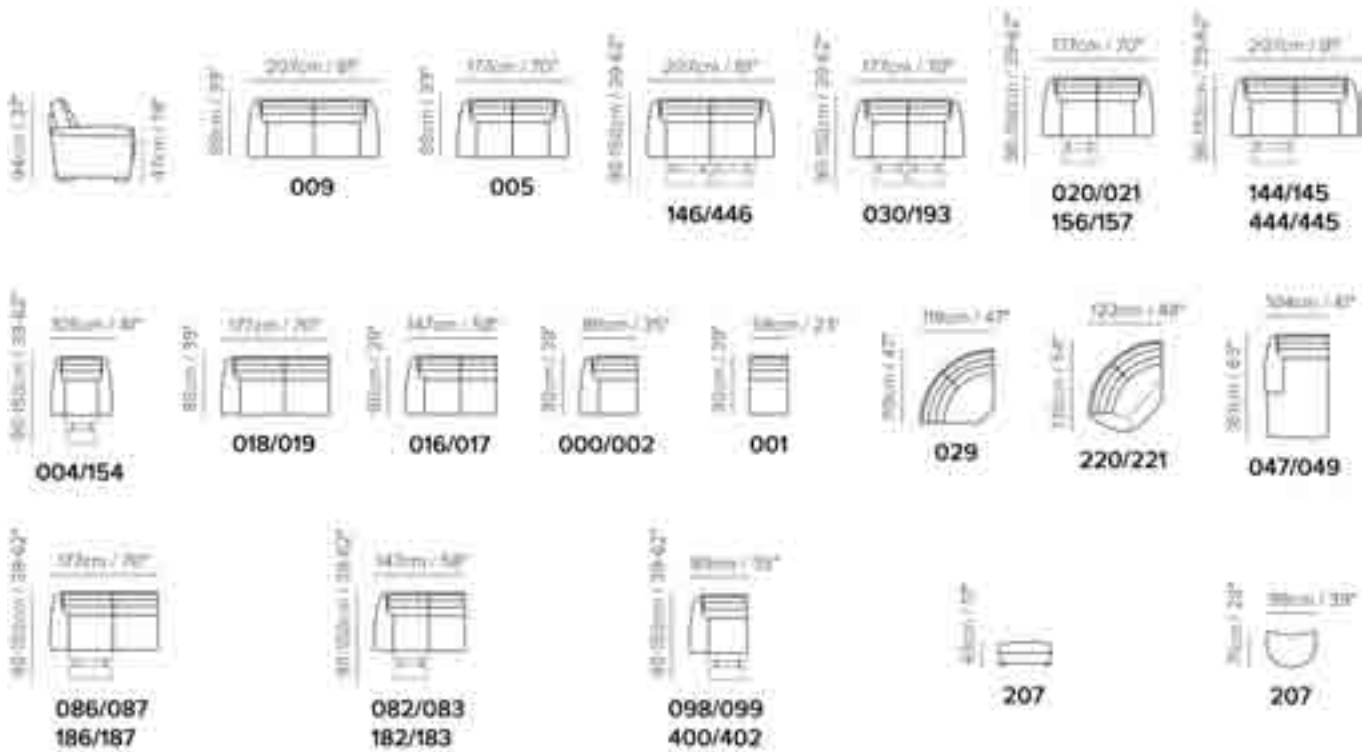



## SCHEMATICS



## COMPOSITION EXAMPLES



## TECHNICAL INFORMATION

	<b>COVERING</b>	Leather <input checked="" type="checkbox"/>	Soft Cover <input checked="" type="checkbox"/>			
	<b>LEGS</b>	Wood <input checked="" type="checkbox"/>	Metal <input type="checkbox"/>	Plastic <input type="checkbox"/>	Castors <input type="checkbox"/>	Upholstered <input type="checkbox"/>
	<b>FILLING</b>	Arms	<input checked="" type="checkbox"/> Fiber <input type="checkbox"/> Foam <input type="checkbox"/> Feather/Fiber Mix <input type="checkbox"/> Feather	Seat cushion	<input type="checkbox"/> Fiber <input checked="" type="checkbox"/> Foam <input type="checkbox"/> Feather/Fiber Mix <input type="checkbox"/> Feather	Back cushion <input checked="" type="checkbox"/> Fiber <input type="checkbox"/> Foam <input type="checkbox"/> Feather/Fiber Mix <input type="checkbox"/> Feather
	<b>COMFORT</b>	Standard Comfort <input checked="" type="checkbox"/>	Firm Comfort <input checked="" type="checkbox"/>			
	<b>FUNCTION</b>	Bed <input type="checkbox"/>	Electric motion <input checked="" type="checkbox"/>	Motion <input checked="" type="checkbox"/>	Recliner <input checked="" type="checkbox"/>	Sliding <input type="checkbox"/>
	<b>OPTIONS</b>	Contrast Stitching <input type="checkbox"/>	Removable <input type="checkbox"/>	Nails <input type="checkbox"/>		

## NOTES

- Tight Seat Cushion (the seat cushions of the models are fixed to the frame)
- Tight Back Cushion (the back cushions of the models are fixed to the frame)
- No Leather Side (the sectional pieces have the side covered with fabric and not leather)
- Wood Frame
- Without Feet Assembled (the feet will be in a bag inside the package)
- Plastic Wrap (the model will be wrapped in a plastic bag)
- Feet available in wood finishings 09 (Walnut) / 18 (Wengè)
- Feet height 4,0 cm

NOTES

---





■ vers. 004



■ vers. 004









■ vers. 004

## SCHEMATICS

---



## TECHNICAL INFORMATION

	<b>COVERING</b>	Leather <input checked="" type="checkbox"/>	Soft Cover <input checked="" type="checkbox"/>			
	<b>LEGS</b>	Wood <input checked="" type="checkbox"/>	Metal <input type="checkbox"/>	Plastic <input type="checkbox"/>	Castors <input type="checkbox"/>	Upholstered <input type="checkbox"/>
	<b>FILLING</b>	Arms <input type="checkbox"/> Fiber <input checked="" type="checkbox"/> Foam <input type="checkbox"/> Feather/Fiber Mix <input type="checkbox"/> Feather	Seat cushion <input type="checkbox"/> Fiber <input checked="" type="checkbox"/> Foam <input type="checkbox"/> Feather/Fiber Mix <input type="checkbox"/> Feather	Back cushion <input type="checkbox"/> Fiber <input checked="" type="checkbox"/> Foam <input type="checkbox"/> Feather/Fiber Mix <input type="checkbox"/> Feather		
	<b>COMFORT</b>	Standard Comfort <input checked="" type="checkbox"/>	Firm Comfort <input checked="" type="checkbox"/>			
	<b>FUNCTION</b>	Bed <input type="checkbox"/>	Electric motion <input type="checkbox"/>	Motion <input type="checkbox"/>	Recliner <input checked="" type="checkbox"/>	Sliding <input type="checkbox"/>
	<b>OPTIONS</b>	Nails <input type="checkbox"/>	Removable <input type="checkbox"/>	Contrast Stitching <input type="checkbox"/>		

## NOTES

- Tight Seat Cushion (the seat cushions of the models are fixed to the frame)
- Tight Back Cushion (the back cushions of the models are fixed to the frame)
- Wood Frame
- Without Feet Assembled (the feet will be in a bag inside the package)
- Plastic Wrap (the model will be wrapped in a plastic bag)
- Front feet are slightly higher in respect to rear.
- Feet available in wood finishings 09 (Walnut) / 18 (Wengè)
- Feet height 12,0/9,0 cm

NOTES

---



■ vers. 009



■ vers. 031



■ vers. 018 + 049





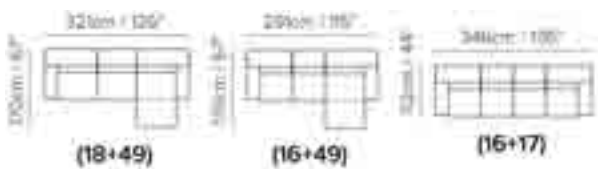

## SCHEMATICS



## COMPOSITION EXAMPLES



## TECHNICAL INFORMATION

	<b>COVERING</b>	Leather <input checked="" type="checkbox"/>				
	<b>LEGS</b>	Wood <input type="checkbox"/>	Metal <input checked="" type="checkbox"/>	Plastic <input type="checkbox"/>	Castors <input type="checkbox"/>	Upholstered <input type="checkbox"/>
	<b>FILLING</b>	Arms <input type="checkbox"/> Fiber <input checked="" type="checkbox"/> Foam <input type="checkbox"/> Feather/Fiber Mix <input type="checkbox"/> Feather	Seat cushion <input type="checkbox"/> Fiber <input checked="" type="checkbox"/> Foam <input checked="" type="checkbox"/> Feather/Fiber Mix <input type="checkbox"/> Feather	Back cushion <input type="checkbox"/> Fiber <input checked="" type="checkbox"/> Foam <input type="checkbox"/> Feather/Fiber Mix <input type="checkbox"/> Feather		
	<b>COMFORT</b>	Standard Comfort <input checked="" type="checkbox"/>	Firm Comfort <input type="checkbox"/>			
	<b>FUNCTION</b>	Bed <input type="checkbox"/>	Electric motion <input type="checkbox"/>	Motion <input type="checkbox"/>	Recliner <input type="checkbox"/>	Sliding <input type="checkbox"/>
	<b>OPTIONS</b>	Contrast Stitching <input checked="" type="checkbox"/>	Removable <input type="checkbox"/>	Nails <input type="checkbox"/>		

## NOTES

- Model also available with thick leather with model code Sxxx (Art. Vesuvio, Cassidy).
- Contrast stitching is available only with certain covers and option is managed directly in NARES.
- Adjustable headrest on all versions.
- Seat cushion includes a layer of memory foam, a pressure-sensitive soft polyurethane, that recovers its form completely thus giving great comfort
- Loose Seat Cushion (the seat cushions of the model are not fixed to the frame)
- Tight Back Cushion (the back cushions of the models are fixed to the frame)
- No Leather Side (the sectional pieces have the side covered with fabric and not leather)
- Wood Frame
- With Feet Assembled (the model will be loaded with feet already mounted on the sofa)
- Feet available in metal finishing 77 (Glossy Chromed)
- Feet height 12,5 cm

NOTES

---





■ vers. 000 + 001 + 002



■ vers. 000 + 001 + 002



■ vers. 003



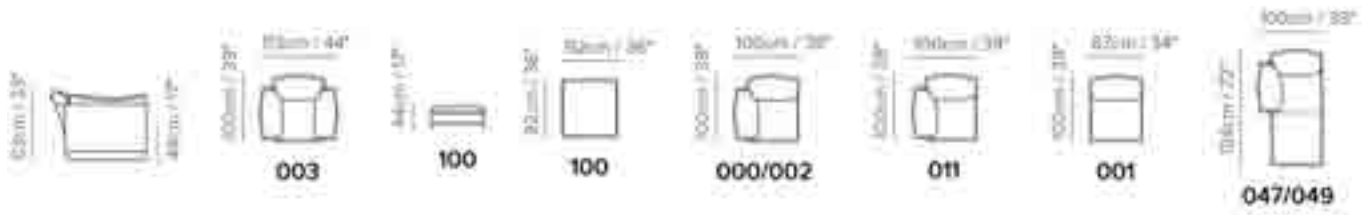

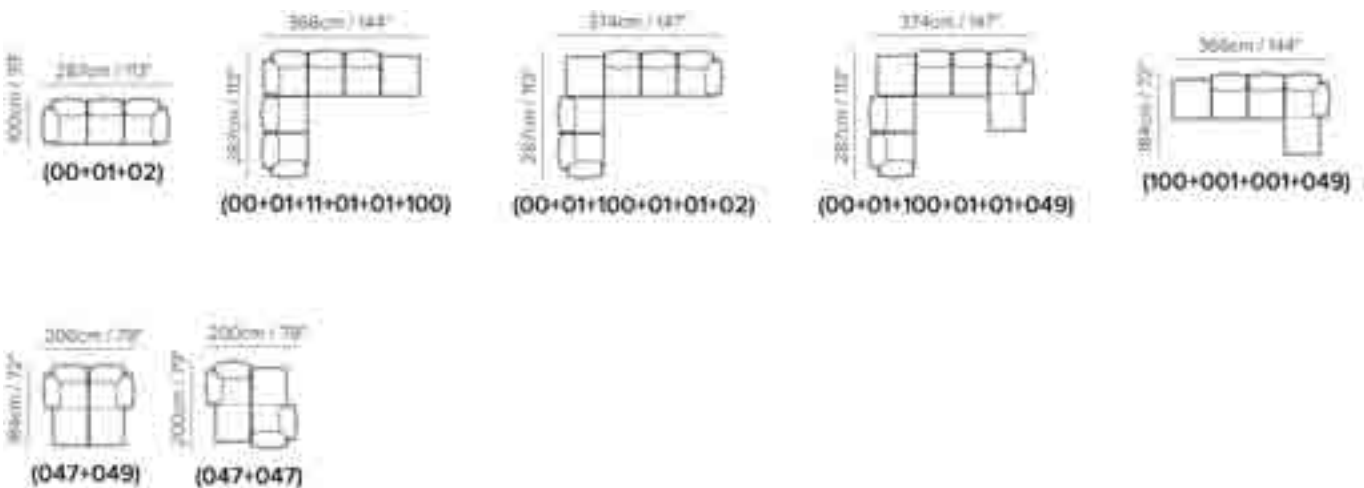

## SCHEMATICS



## COMPOSITION EXAMPLES



## TECHNICAL INFORMATION

	<b>COVERING</b>	Mix <input checked="" type="checkbox"/>	Leather <input checked="" type="checkbox"/>			
	<b>LEGS</b>	Wood <input type="checkbox"/>	Metal <input checked="" type="checkbox"/>	Plastic <input type="checkbox"/>	Castors <input type="checkbox"/>	Upholstered <input type="checkbox"/>
	<b>FILLING</b>	Arms <input type="checkbox"/> Fiber <input checked="" type="checkbox"/> Foam <input type="checkbox"/> Feather/Fiber Mix <input checked="" type="checkbox"/> Feather	Seat cushion <input type="checkbox"/> Fiber <input checked="" type="checkbox"/> Foam <input type="checkbox"/> Feather/Fiber Mix <input checked="" type="checkbox"/> Feather	Back cushion <input type="checkbox"/> Fiber <input checked="" type="checkbox"/> Foam <input type="checkbox"/> Feather/Fiber Mix <input checked="" type="checkbox"/> Feather		
	<b>COMFORT</b>	Standard Comfort <input checked="" type="checkbox"/>	Firm Comfort <input type="checkbox"/>			
	<b>FUNCTION</b>	Bed <input type="checkbox"/>	Electric motion <input type="checkbox"/>	Motion <input type="checkbox"/>	Recliner <input type="checkbox"/>	Sliding <input type="checkbox"/>
	<b>OPTIONS</b>	Nails <input type="checkbox"/>	Removable <input type="checkbox"/>	Contrast Stitching <input type="checkbox"/>		

## NOTES

- Model also available with slipcover with the model code Rxxx.
- Seat cushion includes a layer of memory foam, a pressure-sensitive soft polyurethane, that recovers its form completely thus giving great comfort
- Loose Seat Cushion (the seat cushions of the model are not fixed to the frame)
- Wood Frame
- With Leather Side (the sectional pieces come with leather sides)
- Without Feet Assembled (the feet will be in a bag inside the package)
- Feet available in metal finishing 75 (Glazed Nickel)
- Feet height 12,5 cm
- LEATHER-FABRIC MIX COVERING OPTIONS:
- 1° COV. (Leather) = Frame and flange edge
- 2° COV. (Fabric) = Arms, seat and back cushions

NOTES

---



■ vers. 047 + 000 + 002 + 089



■ vers. 072 + 089 + 011 + 001 + 002 + T110LMS



■ vers. 072 + 011 + 001 + 002



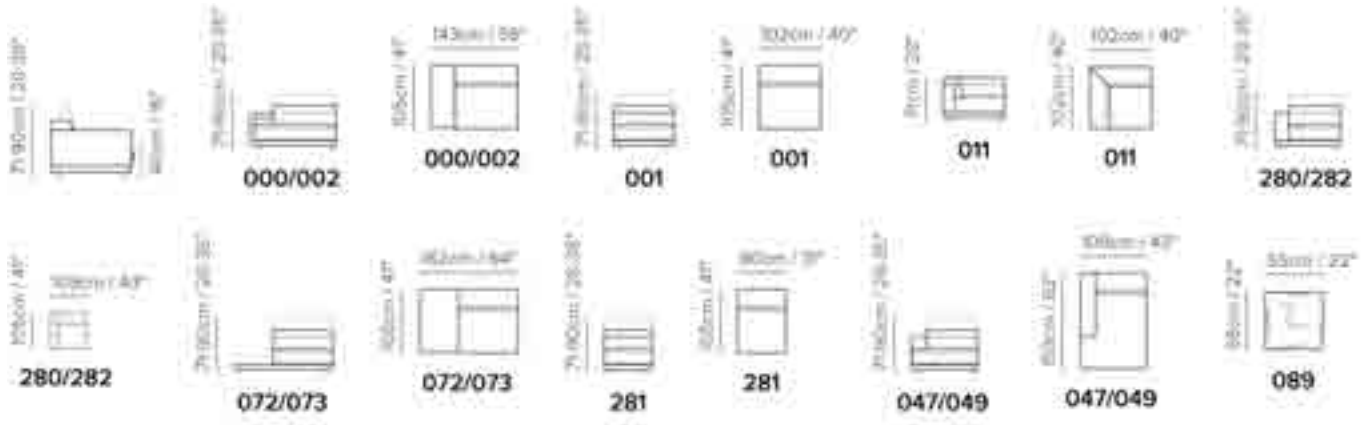

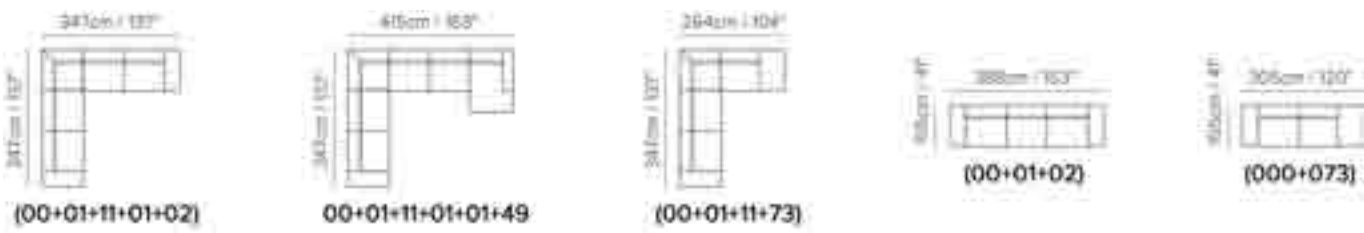

## SCHEMATICS



## COMPOSITION EXAMPLES



## TECHNICAL INFORMATION

	<b>COVERING</b>	Mix <input checked="" type="checkbox"/>	Leather <input checked="" type="checkbox"/>	Soft Cover <input checked="" type="checkbox"/>		
	<b>LEGS</b>	Wood <input type="checkbox"/>	Metal <input checked="" type="checkbox"/>	Plastic <input type="checkbox"/>	Castors <input type="checkbox"/>	Upholstered <input type="checkbox"/>
	<b>FILLING</b>	Arms <input type="checkbox"/> Fiber <input checked="" type="checkbox"/> Foam <input type="checkbox"/> Feather/Fiber Mix <input type="checkbox"/> Feather	Seat cushion <input type="checkbox"/> Fiber <input checked="" type="checkbox"/> Foam <input type="checkbox"/> Feather/Fiber Mix <input type="checkbox"/> Feather	Back cushion <input type="checkbox"/> Fiber <input checked="" type="checkbox"/> Foam <input type="checkbox"/> Feather/Fiber Mix <input type="checkbox"/> Feather		
	<b>COMFORT</b>	Standard Comfort <input checked="" type="checkbox"/>	Firm Comfort <input type="checkbox"/>			
	<b>FUNCTION</b>	Bed <input type="checkbox"/>	Electric motion <input type="checkbox"/>	Motion <input type="checkbox"/>	Recliner <input type="checkbox"/>	Sliding <input type="checkbox"/>
	<b>OPTIONS</b>	Contrast Stitching <input type="checkbox"/>	Removable <input type="checkbox"/>	Nails <input type="checkbox"/>		

## NOTES

- Adjustable headrest on all versions except the corners.
- Loose Seat Cushion (the seat cushions of the model are not fixed to the frame)
- Tight Back Cushion (the back cushions of the models are fixed to the frame)
- With Leather Side (the sectional pieces come with leather sides)
- Wood Frame
- Without Feet Assembled (the feet will be in a bag inside the package)
- Plastic Wrap (the model will be wrapped in a plastic bag)
- Feet available in metal finishing 77 (Glossy Chromed)
- Feet height 4,5 cm
- LEATHER-FABRIC MIX COVERING OPTIONS:
- 1° COV. (Leather) = Frame and arms
- 2° COV. (Fabric) = Seat and back cushions

NOTES

---





■ vers. 003



■ vers. 003









■ vers. 003

## SCHEMATICS

---



## TECHNICAL INFORMATION

	<b>COVERING</b>	Leather <input checked="" type="checkbox"/>				
	<b>LEGS</b>	Wood <input checked="" type="checkbox"/>	Metal <input type="checkbox"/>	Plastic <input type="checkbox"/>	Castors <input type="checkbox"/>	Upholstered <input type="checkbox"/>
	<b>FILLING</b>	Arms <input type="checkbox"/> Fiber <input checked="" type="checkbox"/> Foam <input type="checkbox"/> Feather/Fiber Mix <input type="checkbox"/> Feather	Seat cushion <input type="checkbox"/> Fiber <input checked="" type="checkbox"/> Foam <input type="checkbox"/> Feather/Fiber Mix <input type="checkbox"/> Feather	Back cushion <input type="checkbox"/> Fiber <input checked="" type="checkbox"/> Foam <input type="checkbox"/> Feather/Fiber Mix <input type="checkbox"/> Feather		
	<b>COMFORT</b>	Standard Comfort <input checked="" type="checkbox"/>	Firm Comfort <input type="checkbox"/>			
	<b>FUNCTION</b>	Bed <input type="checkbox"/>	Electric motion <input type="checkbox"/>	Motion <input type="checkbox"/>	Recliner <input type="checkbox"/>	Sliding <input type="checkbox"/>
	<b>OPTIONS</b>	Nails <input type="checkbox"/>	Removable <input type="checkbox"/>	Contrast Stitching <input type="checkbox"/>		

## NOTES

- Model also available with slipcover with the model code Rxxx.
- Tight Seat Cushion (the seat cushions of the models are fixed to the frame)
- Tight Back Cushion (the back cushions of the models are fixed to the frame)
- Wood Frame
- Without Feet Assembled (the feet will be in a bag inside the package)
- Front feet are slightly higher in respect to rear.
- Feet available in wood finishings 09 (Walnut) / 18 (Wengè)
- Feet height 13,0/8,0 cm

NOTES

---



■ vers. 003



■ vers. 003









■ vers. 003

## SCHEMATICS

---



## TECHNICAL INFORMATION

	<b>COVERING</b>	Leather <input checked="" type="checkbox"/>				
	<b>LEGS</b>	Wood <input checked="" type="checkbox"/>	Metal <input type="checkbox"/>	Plastic <input type="checkbox"/>	Castors <input checked="" type="checkbox"/>	Upholstered <input type="checkbox"/>
	<b>FILLING</b>	Arms <input type="checkbox"/> Fiber <input checked="" type="checkbox"/> Foam <input type="checkbox"/> Feather/Fiber Mix <input type="checkbox"/> Feather	Seat cushion <input type="checkbox"/> Fiber <input checked="" type="checkbox"/> Foam <input type="checkbox"/> Feather/Fiber Mix <input type="checkbox"/> Feather	Back cushion <input type="checkbox"/> Fiber <input checked="" type="checkbox"/> Foam <input type="checkbox"/> Feather/Fiber Mix <input type="checkbox"/> Feather		
	<b>COMFORT</b>	Standard Comfort <input checked="" type="checkbox"/>	Firm Comfort <input type="checkbox"/>			
	<b>FUNCTION</b>	Bed <input type="checkbox"/>	Electric motion <input type="checkbox"/>	Motion <input type="checkbox"/>	Recliner <input type="checkbox"/>	Sliding <input type="checkbox"/>
	<b>OPTIONS</b>	Contrast Stitching <input type="checkbox"/>	Removable <input type="checkbox"/>	Nails <input type="checkbox"/>		

## NOTES

- Model also available with slipcover with the model code Rxxx.
- Model is available with contrast welt to be entered as second covering
- Seat cushion includes a layer of memory foam, a pressure-sensitive soft polyurethane, that recovers its form completely thus giving great comfort
- Loose Seat Cushion (the seat cushions of the model are not fixed to the frame)
- Tight Back Cushion (the back cushions of the models are fixed to the frame)
- Wood Frame
- Without Feet Assembled (the feet will be in a bag inside the package)
- Plastic Wrap (the model will be wrapped in a plastic bag)
- Front feet are slightly higher in respect to rear.
- 
- Feet available in wood finishings 09 (Walnut) / 18 (Wengè)
- Feet height 18,0/13,0 cm

NOTES

---





■ vers. 064



■ vers. 064







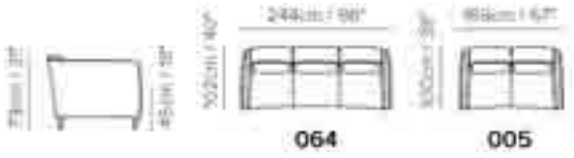

■ vers. 064

## SCHEMATICS

---



## TECHNICAL INFORMATION

	<b>COVERING</b>	Leather <input checked="" type="checkbox"/>				
	<b>LEGS</b>	Wood <input checked="" type="checkbox"/>	Metal <input type="checkbox"/>	Plastic <input type="checkbox"/>	Castors <input type="checkbox"/>	Upholstered <input type="checkbox"/>
	<b>FILLING</b>	Arms <input type="checkbox"/> Fiber <input checked="" type="checkbox"/> Foam <input type="checkbox"/> Feather/Fiber Mix <input type="checkbox"/> Feather	Seat cushion <input type="checkbox"/> Fiber <input checked="" type="checkbox"/> Foam <input checked="" type="checkbox"/> Feather/Fiber Mix <input type="checkbox"/> Feather	Back cushion <input type="checkbox"/> Fiber <input checked="" type="checkbox"/> Foam <input checked="" type="checkbox"/> Feather/Fiber Mix <input type="checkbox"/> Feather		
	<b>COMFORT</b>	Standard Comfort <input checked="" type="checkbox"/>	Firm Comfort <input type="checkbox"/>			
	<b>FUNCTION</b>	Bed <input type="checkbox"/>	Electric motion <input type="checkbox"/>	Motion <input type="checkbox"/>	Recliner <input type="checkbox"/>	Sliding <input type="checkbox"/>
	<b>OPTIONS</b>	Nails <input type="checkbox"/>	Removable <input type="checkbox"/>	Contrast Stitching <input type="checkbox"/>		

## NOTES

- Model is available with contrast welt to be entered as second covering
- Loose Seat Cushion (the seat cushions of the model are not fixed to the frame)
- Wood Frame
- Without Feet Assembled (the feet will be in a bag inside the package)
- Plastic Wrap (the model will be wrapped in a plastic bag)
- Feet available in wood finishings 09 (Walnut) / 18 (Wengè)
- Feet height 13,0 cm

NOTES

---



■ vers. 003



■ vers. 003









■ vers. 003

## SCHEMATICS

---



## TECHNICAL INFORMATION

	<b>COVERING</b>	Leather <input checked="" type="checkbox"/>	Soft Cover <input checked="" type="checkbox"/>			
	<b>LEGS</b>	Wood <input type="checkbox"/>	Metal <input checked="" type="checkbox"/>	Plastic <input type="checkbox"/>	Castors <input type="checkbox"/>	Upholstered <input type="checkbox"/>
	<b>FILLING</b>	Arms <input type="checkbox"/> Fiber <input checked="" type="checkbox"/> Foam <input type="checkbox"/> Feather/Fiber Mix <input type="checkbox"/> Feather	Seat cushion <input type="checkbox"/> Fiber <input checked="" type="checkbox"/> Foam <input type="checkbox"/> Feather/Fiber Mix <input type="checkbox"/> Feather	Back cushion <input type="checkbox"/> Fiber <input checked="" type="checkbox"/> Foam <input type="checkbox"/> Feather/Fiber Mix <input type="checkbox"/> Feather		
	<b>COMFORT</b>	Standard Comfort <input checked="" type="checkbox"/>	Firm Comfort <input type="checkbox"/>			
	<b>FUNCTION</b>	Bed <input type="checkbox"/>	Electric motion <input type="checkbox"/>	Motion <input type="checkbox"/>	Recliner <input type="checkbox"/>	Sliding <input type="checkbox"/>
	<b>OPTIONS</b>	Contrast Stitching <input type="checkbox"/>	Removable <input type="checkbox"/>	Nails <input type="checkbox"/>		

## NOTES

- Tight Seat Cushion (the seat cushions of the models are fixed to the frame)
- Tight Back Cushion (the back cushions of the models are fixed to the frame)
- Wood Frame
- Without Feet Assembled (the feet will be in a bag inside the package)
- Plastic Wrap (the model will be wrapped in a plastic bag)
- Feet available in metal finishing 75 (Glazed Nickel)
- Feet height 18,0 cm

NOTES

---





■ vers. 446



■ vers. 446







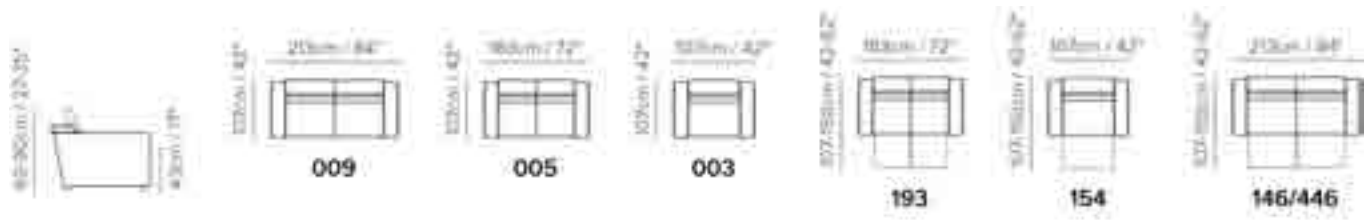

■ vers. 004

## SCHEMATICS

---



## TECHNICAL INFORMATION

	<b>COVERING</b>	Leather <input checked="" type="checkbox"/>				
	<b>LEGS</b>	Wood <input type="checkbox"/>	Metal <input type="checkbox"/>	Plastic <input checked="" type="checkbox"/>	Castors <input type="checkbox"/>	Upholstered <input type="checkbox"/>
	<b>FILLING</b>	Arms <input type="checkbox"/> Fiber <input checked="" type="checkbox"/> Foam <input type="checkbox"/> Feather/Fiber Mix <input type="checkbox"/> Feather	Seat cushion <input type="checkbox"/> Fiber <input checked="" type="checkbox"/> Foam <input type="checkbox"/> Feather/Fiber Mix <input type="checkbox"/> Feather	Back cushion <input type="checkbox"/> Fiber <input checked="" type="checkbox"/> Foam <input type="checkbox"/> Feather/Fiber Mix <input type="checkbox"/> Feather		
	<b>COMFORT</b>	Standard Comfort <input checked="" type="checkbox"/>	Firm Comfort <input checked="" type="checkbox"/>			
	<b>FUNCTION</b>	Bed <input type="checkbox"/>	Electric motion <input checked="" type="checkbox"/>	Motion <input checked="" type="checkbox"/>	Recliner <input checked="" type="checkbox"/>	Sliding <input type="checkbox"/>
	<b>OPTIONS</b>	Nails <input type="checkbox"/>	Removable <input type="checkbox"/>	Contrast Stitching <input type="checkbox"/>		

## NOTES

- Adjustable headrest on all versions.
- Seat cushion includes a layer of memory foam, a pressure-sensitive soft polyurethane, that recovers its form completely thus giving great comfort
- Tight Seat Cushion (the seat cushions of the models are fixed to the frame)
- Tight Back Cushion (the back cushions of the models are fixed to the frame)
- Wood Frame
- Without Feet Assembled (the feet will be in a bag inside the package)
- Plastic Wrap (the model will be wrapped in a plastic bag)
- Feet height 3,0 cm

NOTES

---



■ vers. 003



■ vers. 003









■ vers. 003

## SCHEMATICS

---



## TECHNICAL INFORMATION

	<b>COVERING</b>	Leather <input checked="" type="checkbox"/>				
	<b>LEGS</b>	Wood <input checked="" type="checkbox"/>	Metal <input type="checkbox"/>	Plastic <input type="checkbox"/>	Castors <input type="checkbox"/>	Upholstered <input type="checkbox"/>
	<b>FILLING</b>	Arms <input type="checkbox"/> Fiber <input checked="" type="checkbox"/> Foam <input type="checkbox"/> Feather/Fiber Mix <input type="checkbox"/> Feather	Seat cushion <input type="checkbox"/> Fiber <input checked="" type="checkbox"/> Foam <input type="checkbox"/> Feather/Fiber Mix <input type="checkbox"/> Feather	Back cushion <input type="checkbox"/> Fiber <input checked="" type="checkbox"/> Foam <input type="checkbox"/> Feather/Fiber Mix <input type="checkbox"/> Feather		
	<b>COMFORT</b>	Standard Comfort <input checked="" type="checkbox"/>	Firm Comfort <input type="checkbox"/>			
	<b>FUNCTION</b>	Bed <input type="checkbox"/>	Electric motion <input type="checkbox"/>	Motion <input type="checkbox"/>	Recliner <input type="checkbox"/>	Sliding <input type="checkbox"/>
	<b>OPTIONS</b>	Contrast Stitching <input type="checkbox"/>	Removable <input type="checkbox"/>	Nails <input type="checkbox"/>		

## NOTES

- LEATHER: Model is not available with articles Phoenix and Davinci.
- Stitching is always grey.
- Polyurethane which meets California/UK fire-resistance requirements.
- Expanded polyurethane seat and back.
- Tight Seat Cushion (the seat cushions of the models are fixed to the frame)
- Tight Back Cushion (the back cushions of the models are fixed to the frame)
- Structure in solid ashwood.
- Rag-applied finish, grey or smoked oak, with 5 gloss opaque transparent protective acrylic paint.
- With Feet Assembled (the model will be loaded with feet already mounted on the sofa)
- Legs with felt pads.
- Feet available in (01) Matte Grey or (02) Smoked Ashwood.
- Feet height 40,0 cm

NOTES

---





■ vers. 003



■ vers. 003







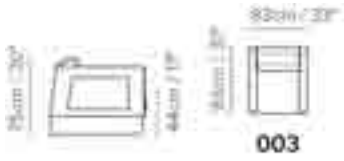

■ vers. 003

## SCHEMATICS

---



## TECHNICAL INFORMATION

	<b>COVERING</b>	Leather <input checked="" type="checkbox"/>	Soft Cover <input checked="" type="checkbox"/>			
	<b>LEGS</b>	Wood <input type="checkbox"/>	Metal <input checked="" type="checkbox"/>	Plastic <input type="checkbox"/>	Castors <input type="checkbox"/>	Upholstered <input type="checkbox"/>
	<b>FILLING</b>	Arms <input type="checkbox"/> Fiber <input checked="" type="checkbox"/> Foam <input type="checkbox"/> Feather/Fiber Mix <input type="checkbox"/> Feather	Seat cushion <input type="checkbox"/> Fiber <input checked="" type="checkbox"/> Foam <input type="checkbox"/> Feather/Fiber Mix <input type="checkbox"/> Feather	Back cushion <input type="checkbox"/> Fiber <input checked="" type="checkbox"/> Foam <input type="checkbox"/> Feather/Fiber Mix <input type="checkbox"/> Feather		
	<b>COMFORT</b>	Standard Comfort <input checked="" type="checkbox"/>	Firm Comfort <input type="checkbox"/>			
	<b>FUNCTION</b>	Bed <input type="checkbox"/>	Electric motion <input type="checkbox"/>	Motion <input type="checkbox"/>	Recliner <input type="checkbox"/>	Sliding <input type="checkbox"/>
	<b>OPTIONS</b>	Nails <input type="checkbox"/>	Removable <input type="checkbox"/>	Contrast Stitching <input type="checkbox"/>		

## NOTES

- Model also available with slipcover with the model code Rxxx.
- Tight Seat Cushion (the seat cushions of the models are fixed to the frame)
- Tight Back Cushion (the back cushions of the models are fixed to the frame)
- Wood Frame
- With Feet Assembled (the model will be loaded with feet already mounted on the sofa)
- Feet available in metal finishing 77 (Glossy Chromed)
- Feet height 18,0 cm

NOTES

---



■ vers. 003



■ vers. 003







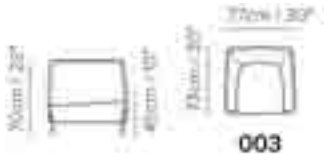

■ vers. 003

## SCHEMATICS

---



## TECHNICAL INFORMATION

	<b>COVERING</b>	Leather <input checked="" type="checkbox"/>	Soft Cover <input checked="" type="checkbox"/>			
	<b>LEGS</b>	Wood <input type="checkbox"/>	Metal <input checked="" type="checkbox"/>	Plastic <input type="checkbox"/>	Castors <input type="checkbox"/>	Upholstered <input type="checkbox"/>
	<b>FILLING</b>	Arms <input type="checkbox"/> Fiber <input checked="" type="checkbox"/> Foam <input type="checkbox"/> Feather/Fiber Mix <input type="checkbox"/> Feather	Seat cushion <input type="checkbox"/> Fiber <input checked="" type="checkbox"/> Foam <input type="checkbox"/> Feather/Fiber Mix <input type="checkbox"/> Feather	Back cushion <input type="checkbox"/> Fiber <input checked="" type="checkbox"/> Foam <input type="checkbox"/> Feather/Fiber Mix <input type="checkbox"/> Feather		
	<b>COMFORT</b>	Standard Comfort <input checked="" type="checkbox"/>	Firm Comfort <input type="checkbox"/>			
	<b>FUNCTION</b>	Bed <input type="checkbox"/>	Electric motion <input type="checkbox"/>	Motion <input type="checkbox"/>	Recliner <input type="checkbox"/>	Sliding <input type="checkbox"/>
	<b>OPTIONS</b>	Contrast Stitching <input type="checkbox"/>	Removable <input type="checkbox"/>	Nails <input type="checkbox"/>		

## NOTES

- Loose Seat Cushion (the seat cushions of the model are not fixed to the frame)
- Tight Back Cushion (the back cushions of the models are fixed to the frame)
- Wood Frame
- With Feet Assembled (the model will be loaded with feet already mounted on the sofa)
- Feet available in metal finishings 77 (Glossy Chromed) / 78 (Glossy Black)
- Feet height 11,5 cm







■ vers. 231



■ vers. 231







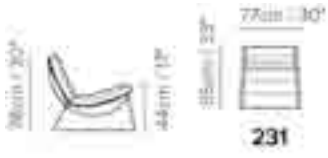

■ vers. 231

## SCHEMATICS

---



## TECHNICAL INFORMATION

	<b>COVERING</b>	Leather <input checked="" type="checkbox"/>	Soft Cover <input checked="" type="checkbox"/>			
	<b>LEGS</b>	Wood <input type="checkbox"/>	Metal <input checked="" type="checkbox"/>	Plastic <input type="checkbox"/>	Castors <input type="checkbox"/>	Upholstered <input type="checkbox"/>
	<b>FILLING</b>	Arms <input type="checkbox"/> Fiber <input checked="" type="checkbox"/> Foam <input type="checkbox"/> Feather/Fiber Mix <input type="checkbox"/> Feather	Seat cushion <input type="checkbox"/> Fiber <input checked="" type="checkbox"/> Foam <input type="checkbox"/> Feather/Fiber Mix <input type="checkbox"/> Feather	Back cushion <input type="checkbox"/> Fiber <input checked="" type="checkbox"/> Foam <input type="checkbox"/> Feather/Fiber Mix <input type="checkbox"/> Feather		
	<b>COMFORT</b>	Standard Comfort <input checked="" type="checkbox"/>	Firm Comfort <input type="checkbox"/>			
	<b>FUNCTION</b>	Bed <input type="checkbox"/>	Electric motion <input type="checkbox"/>	Motion <input type="checkbox"/>	Recliner <input type="checkbox"/>	Sliding <input type="checkbox"/>
	<b>OPTIONS</b>	Nails <input type="checkbox"/>	Removable <input type="checkbox"/>	Contrast Stitching <input type="checkbox"/>		

## NOTES

- Seat cushion zippered (the seat cushion is attached to the frame through a zipper)
- Back Cushion Zippered (the back cushion is attached to the frame through a zipper)
- Metal Frame
- With Feet Assembled (the model will be loaded with feet already mounted on the sofa)
- Feet available in metal finishing 77 (Glossy Chromed)
- For order entry purposes, specify color (01) White, (02) Black or (03) Dark Brown for outside back cover.

NOTES

---



■ vers. 009



■ vers. 233



■ vers. 000 + 073



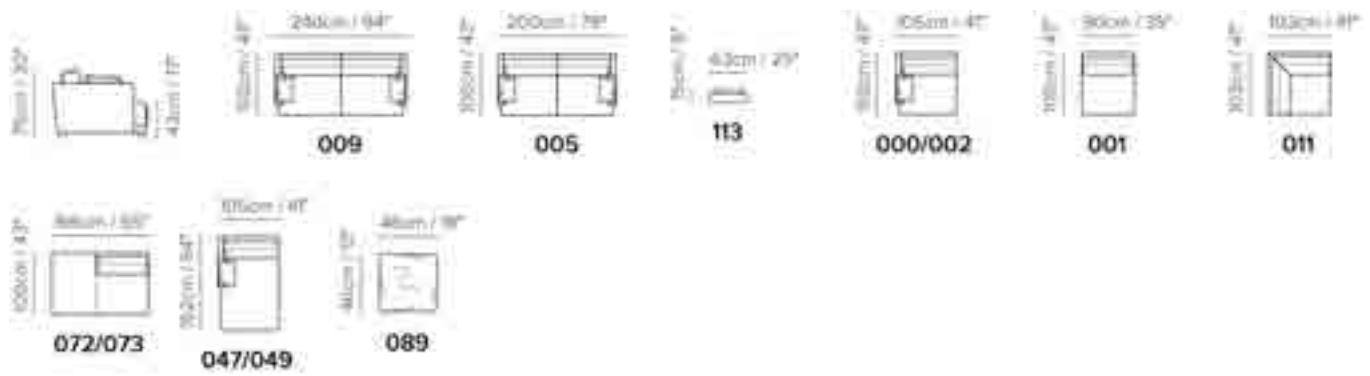



## SCHEMATICS



## COMPOSITION EXAMPLES



## TECHNICAL INFORMATION

	<b>COVERING</b>	Leather <input checked="" type="checkbox"/>				
	<b>LEGS</b>	Wood <input checked="" type="checkbox"/>	Metal <input type="checkbox"/>	Plastic <input type="checkbox"/>	Castors <input type="checkbox"/>	Upholstered <input type="checkbox"/>
	<b>FILLING</b>	Arms <input type="checkbox"/> Fiber <input checked="" type="checkbox"/> Foam <input type="checkbox"/> Feather/Fiber Mix <input type="checkbox"/> Feather	Seat cushion <input type="checkbox"/> Fiber <input checked="" type="checkbox"/> Foam <input checked="" type="checkbox"/> Feather/Fiber Mix <input type="checkbox"/> Feather	Back cushion <input type="checkbox"/> Fiber <input checked="" type="checkbox"/> Foam <input checked="" type="checkbox"/> Feather/Fiber Mix <input type="checkbox"/> Feather		
	<b>COMFORT</b>	Standard Comfort <input checked="" type="checkbox"/>	Firm Comfort <input type="checkbox"/>			
	<b>FUNCTION</b>	Bed <input type="checkbox"/>	Electric motion <input type="checkbox"/>	Motion <input type="checkbox"/>	Recliner <input type="checkbox"/>	Sliding <input type="checkbox"/>
	<b>OPTIONS</b>	Contrast Stitching <input type="checkbox"/>	Removable <input type="checkbox"/>	Nails <input type="checkbox"/>		

## NOTES

- Model also available with slipcover with the model code Rxxx.
- Seat cushion includes a layer of memory foam, a pressure-sensitive soft polyurethane, that recovers its form completely thus giving great comfort
- Loose Seat Cushion (the seat cushions of the model are not fixed to the frame)
- With Leather Side (the sectional pieces come with leather sides)
- Wood Frame
- Without Feet Assembled (the feet will be in a bag inside the package)
- Feet available in wood finishing 28 (Grey)
- Feet height 5,5 cm
- Versions 000/002/047/049 include only 1 small cushion.
- Versions 005/009 include 2 small cushions.
- Second option version 233 has higher back seat. The headrest is not adjustable.

NOTES

---





■ vers. 010



■ vers.100









■ vers. 104

### SCHEMATICS

---



## TECHNICAL INFORMATION

	<b>COVERING</b>	Leather <input checked="" type="checkbox"/>	Soft Cover <input checked="" type="checkbox"/>			
	<b>LEGS</b>	Wood <input type="checkbox"/>	Metal <input type="checkbox"/>	Plastic <input checked="" type="checkbox"/>	Castors <input checked="" type="checkbox"/>	Upholstered <input type="checkbox"/>
	<b>FILLING</b>	Arms <input type="checkbox"/> Fiber <input checked="" type="checkbox"/> Foam <input type="checkbox"/> Feather/Fiber Mix <input type="checkbox"/> Feather	Seat cushion <input type="checkbox"/> Fiber <input checked="" type="checkbox"/> Foam <input type="checkbox"/> Feather/Fiber Mix <input type="checkbox"/> Feather	Back cushion <input type="checkbox"/> Fiber <input checked="" type="checkbox"/> Foam <input type="checkbox"/> Feather/Fiber Mix <input type="checkbox"/> Feather		
	<b>COMFORT</b>	Standard Comfort <input checked="" type="checkbox"/>	Firm Comfort <input type="checkbox"/>			
	<b>FUNCTION</b>	Bed <input type="checkbox"/>	Electric motion <input type="checkbox"/>	Motion <input type="checkbox"/>	Recliner <input type="checkbox"/>	Sliding <input type="checkbox"/>
	<b>OPTIONS</b>	Nails <input type="checkbox"/>	Removable <input type="checkbox"/>	Contrast Stitching <input type="checkbox"/>		

## NOTES

- Model available with accents fabric Dama, Elliott, Palace, Fiume
- Model also available with slipcover with the model code Rxxx.
- Wood Frame
- Without Feet Assembled (the feet will be in a bag inside the package)
- Plastic Wrap (the model will be wrapped in a plastic bag)
- Feet height 2,0 cm
- Stitching is always in taupe.

NOTES

---



■ vers. 005



■ vers. 016 + 049



■ vers. 200 + 019



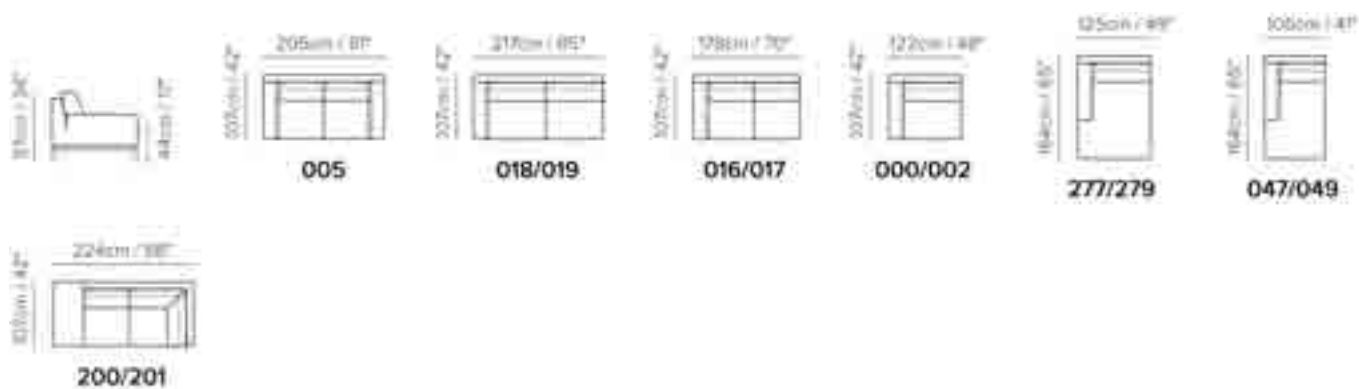



## SCHEMATICS



## COMPOSITION EXAMPLES



## TECHNICAL INFORMATION

	<b>COVERING</b>	Leather <input checked="" type="checkbox"/>					
	<b>LEGS</b>	Wood <input checked="" type="checkbox"/>	Metal <input type="checkbox"/>	Plastic <input type="checkbox"/>	Castors <input type="checkbox"/>	Upholstered <input type="checkbox"/>	
	<b>FILLING</b>	Arms	<input type="checkbox"/> Fiber <input checked="" type="checkbox"/> Foam <input type="checkbox"/> Feather/Fiber Mix <input checked="" type="checkbox"/> Feather	Seat cushion	<input type="checkbox"/> Fiber <input checked="" type="checkbox"/> Foam <input type="checkbox"/> Feather/Fiber Mix <input checked="" type="checkbox"/> Feather	Back cushion	<input type="checkbox"/> Fiber <input checked="" type="checkbox"/> Foam <input type="checkbox"/> Feather/Fiber Mix <input checked="" type="checkbox"/> Feather
	<b>COMFORT</b>	Standard Comfort <input checked="" type="checkbox"/>	Firm Comfort <input type="checkbox"/>				
	<b>FUNCTION</b>	Bed <input type="checkbox"/>	Electric motion <input type="checkbox"/>	Motion <input type="checkbox"/>	Recliner <input type="checkbox"/>	Sliding <input type="checkbox"/>	
	<b>OPTIONS</b>	Contrast Stitching <input type="checkbox"/>	Removable <input type="checkbox"/>	Nails <input type="checkbox"/>			

## NOTES

- Model also available with thick leather with model code Sxxx (Art. Vesuvio, Cassidy).
- Model is available with contrast welt to be entered as second covering
- Seat cushion includes a layer of memory foam, a pressure-sensitive soft polyurethane, that recovers its form completely thus giving great comfort
- Loose Seat Cushion (the seat cushions of the model are not fixed to the frame)
- With Leather Side (the sectional pieces come with leather sides)
- Wood Frame
- Without Feet Assembled (the feet will be in a bag inside the package)
- Feet available in wood finishing 29 (Coffee)
- Feet height 20,0 cm

NOTES

---





■ vers. 009



■ vers. 446



■ vers. 016 + 049



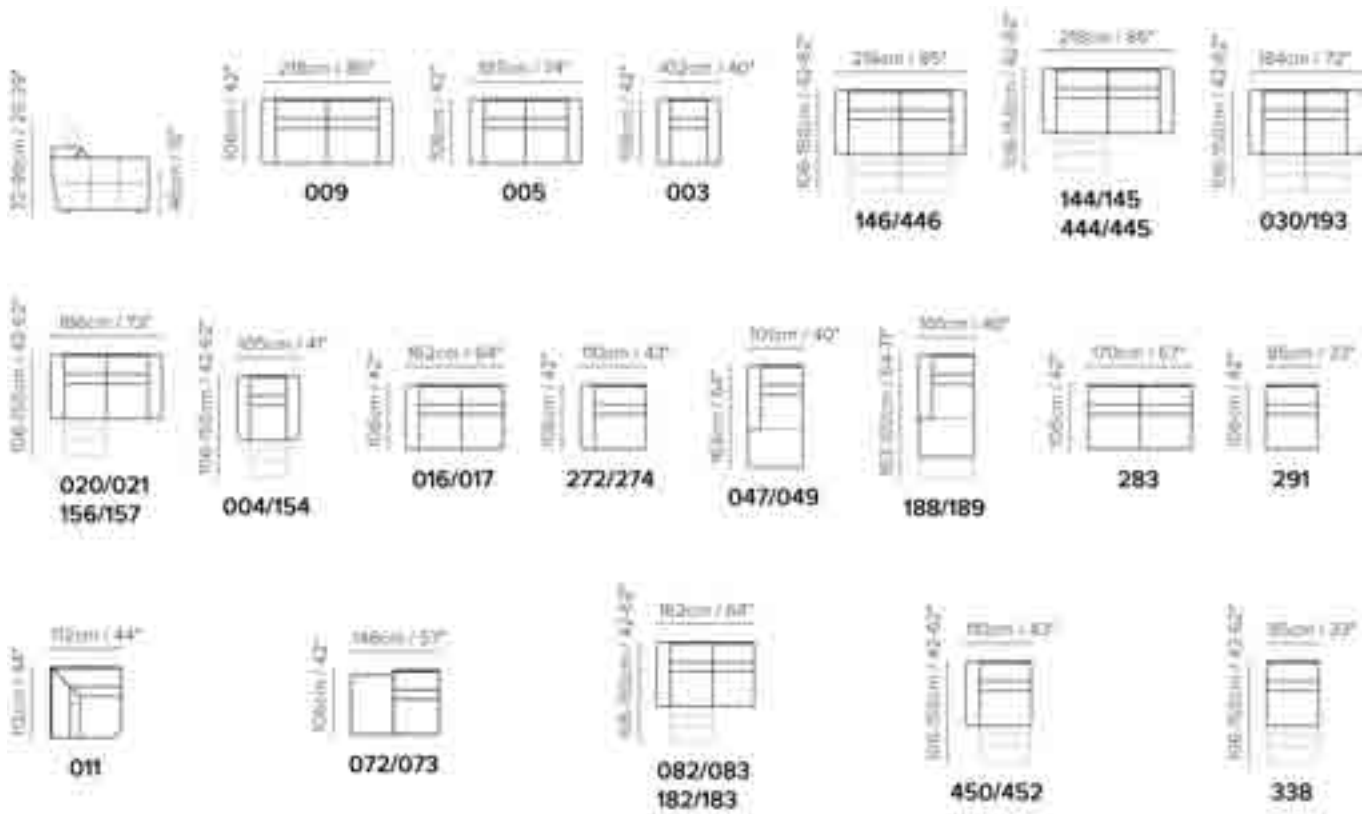



## SCHEMATICS



## COMPOSITION EXAMPLES



## TECHNICAL INFORMATION

	<b>COVERING</b>	Leather <input checked="" type="checkbox"/>	Soft Cover <input checked="" type="checkbox"/>			
	<b>LEGS</b>	Wood <input type="checkbox"/>	Metal <input type="checkbox"/>	Plastic <input checked="" type="checkbox"/>	Castors <input type="checkbox"/>	Upholstered <input type="checkbox"/>
	<b>FILLING</b>	Arms <input type="checkbox"/> Fiber <input checked="" type="checkbox"/> Foam <input type="checkbox"/> Feather/Fiber Mix <input type="checkbox"/> Feather	Seat cushion <input type="checkbox"/> Fiber <input checked="" type="checkbox"/> Foam <input type="checkbox"/> Feather/Fiber Mix <input type="checkbox"/> Feather	Back cushion <input type="checkbox"/> Fiber <input checked="" type="checkbox"/> Foam <input type="checkbox"/> Feather/Fiber Mix <input type="checkbox"/> Feather		
	<b>COMFORT</b>	Standard Comfort <input checked="" type="checkbox"/>	Firm Comfort <input checked="" type="checkbox"/>			
	<b>FUNCTION</b>	Bed <input type="checkbox"/>	Electric motion <input checked="" type="checkbox"/>	Motion <input checked="" type="checkbox"/>	Recliner <input checked="" type="checkbox"/>	Sliding <input type="checkbox"/>
	<b>OPTIONS</b>	Nails <input type="checkbox"/>	Removable <input type="checkbox"/>	Contrast Stitching <input type="checkbox"/>		

## NOTES

- In leather cat. 10 model is available only with article San Marco.
- Adjustable headrest on all versions.
- Seat cushion includes a layer of memory foam, a pressure-sensitive soft polyurethane, that recovers its form completely thus giving great comfort
- Tight Seat Cushion (the seat cushions of the models are fixed to the frame)
- Tight Back Cushion (the back cushions of the models are fixed to the frame)
- Wood Frame
- Without Feet Assembled (the feet will be in a bag inside the package)
- Feet height 3,0 cm

NOTES

---



■ vers. 009



■ vers. 016 + 049



■ vers. 018 + 481



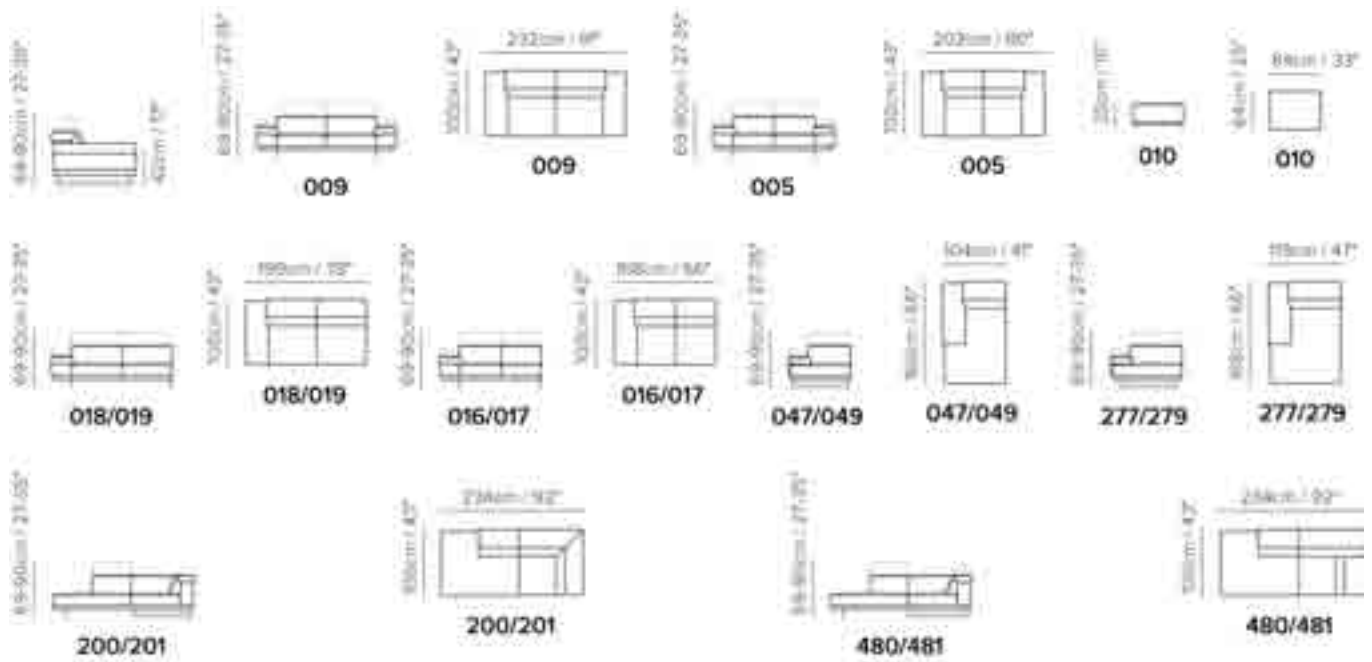



## SCHEMATICS



## COMPOSITION EXAMPLES



## TECHNICAL INFORMATION

	<b>COVERING</b>	Leather <input checked="" type="checkbox"/>	Soft Cover <input checked="" type="checkbox"/>			
	<b>LEGS</b>	Wood <input type="checkbox"/>	Metal <input checked="" type="checkbox"/>	Plastic <input type="checkbox"/>	Castors <input type="checkbox"/>	Upholstered <input type="checkbox"/>
	<b>FILLING</b>	Arms <input type="checkbox"/> Fiber <input checked="" type="checkbox"/> Foam <input type="checkbox"/> Feather/Fiber Mix <input type="checkbox"/> Feather	Seat cushion <input type="checkbox"/> Fiber <input checked="" type="checkbox"/> Foam <input type="checkbox"/> Feather/Fiber Mix <input type="checkbox"/> Feather	Back cushion <input type="checkbox"/> Fiber <input checked="" type="checkbox"/> Foam <input type="checkbox"/> Feather/Fiber Mix <input type="checkbox"/> Feather		
	<b>COMFORT</b>	Standard Comfort <input checked="" type="checkbox"/>	Firm Comfort <input type="checkbox"/>			
	<b>FUNCTION</b>	Bed <input type="checkbox"/>	Electric motion <input type="checkbox"/>	Motion <input type="checkbox"/>	Recliner <input type="checkbox"/>	Sliding <input type="checkbox"/>
	<b>OPTIONS</b>	Contrast Stitching <input type="checkbox"/>	Removable <input type="checkbox"/>	Nails <input type="checkbox"/>		

## NOTES

- In leather cat. 10 model is available only with article San Marco.
- Adjustable headrest on all versions.
- Versions 200/201 have terminal seats with fixed backrests.
- Versions 480/481 have terminal seats with adjustable backrests.
- Adjustable arm
- Seat cushion includes a layer of memory foam, a pressure-sensitive soft polyurethane, that recovers its form completely thus giving great comfort
- Tight Seat Cushion (the seat cushions of the models are fixed to the frame)
- Tight Back Cushion (the back cushions of the models are fixed to the frame)
- With Leather Side (the sectional pieces come with leather sides)
- Wood Frame
- Without Feet Assembled (the feet will be in a bag inside the package)
- Plastic Wrap (the model will be wrapped in a plastic bag)
- Feet available in metal finishing 77 (Glossy Chromed)
- Feet height 12,0 cm

NOTES

---





■ vers. 264



■ vers. 264



■ vers. 264



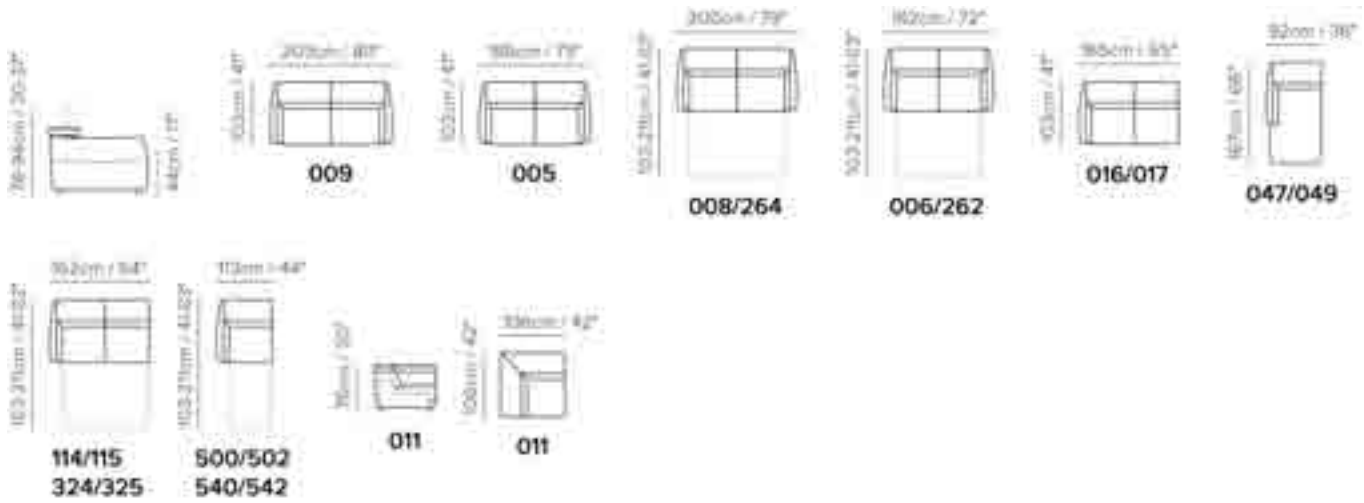



### SCHEMATICS



### COMPOSITION EXAMPLES



## TECHNICAL INFORMATION

	<b>COVERING</b>	Leather <input checked="" type="checkbox"/>	Soft Cover <input checked="" type="checkbox"/>			
	<b>LEGS</b>	Wood <input checked="" type="checkbox"/>	Metal <input type="checkbox"/>	Plastic <input type="checkbox"/>	Castors <input type="checkbox"/>	Upholstered <input type="checkbox"/>
	<b>FILLING</b>	Arms <input type="checkbox"/> Fiber <input checked="" type="checkbox"/> Foam <input type="checkbox"/> Feather/Fiber Mix <input type="checkbox"/> Feather	Seat cushion <input type="checkbox"/> Fiber <input checked="" type="checkbox"/> Foam <input type="checkbox"/> Feather/Fiber Mix <input type="checkbox"/> Feather	Back cushion <input type="checkbox"/> Fiber <input checked="" type="checkbox"/> Foam <input type="checkbox"/> Feather/Fiber Mix <input type="checkbox"/> Feather		
	<b>COMFORT</b>	Standard Comfort <input checked="" type="checkbox"/>	Firm Comfort <input checked="" type="checkbox"/>			
	<b>FUNCTION</b>	Bed <input checked="" type="checkbox"/>	Electric motion <input type="checkbox"/>	Motion <input type="checkbox"/>	Recliner <input type="checkbox"/>	Sliding <input type="checkbox"/>
	<b>OPTIONS</b>	Nails <input type="checkbox"/>	Removable <input type="checkbox"/>	Contrast Stitching <input type="checkbox"/>		

## BED MECHANISM & MATTRESS

MECHANISM		MATTRESS		
VERSIONS	TYPE	VERSIONS	TYPE	DIMENSIONS
				W L H
500,502,540,542	Ready-Bed electro-welded - Double folding	500,502	Spring	70 191 13,5
006,114,115,262,324,325	Ready-Bed electro-welded - Double folding	540,542	GREENPLUS	70 193 14
008,264	Ready-Bed electro-welded - Double folding	006,114,115	Spring	120 190 14
		262,324,325	GREENPLUS	120 193 14
		008	Spring	140 190 14
		264	GREENPLUS	140 193 14

**Ready-Bed electro-welded**  
**GREENPLUS**

The back cushion goes under the bed mechanism which contains a set of pillow holder.

GREENPLUS mattress is a patented, innovative product. It is ecological, made up of microporous elastomers. It has a great adaptation capacity to the various body pressure which gives big support to the spine. It is antibacterial and no-allergic.

## NOTES

- Adjustable headrest on all versions.
- Loose Seat Cushion (the seat cushions of the model are not fixed to the frame)
- Tight Back Cushion (the back cushions of the models are fixed to the frame)
- Wood Frame
- Without Feet Assembled (the feet will be in a bag inside the package)
- Plastic Wrap (the model will be wrapped in a plastic bag)
- Feet available in wood finishings 09 (Walnut) / 18 (Wengè)
- Feet height 6,5 cm

NOTES

---



■ vers. 088



■ vers. 047 + 217



■ vers. 216 + 049 + 113 + 089 + 123



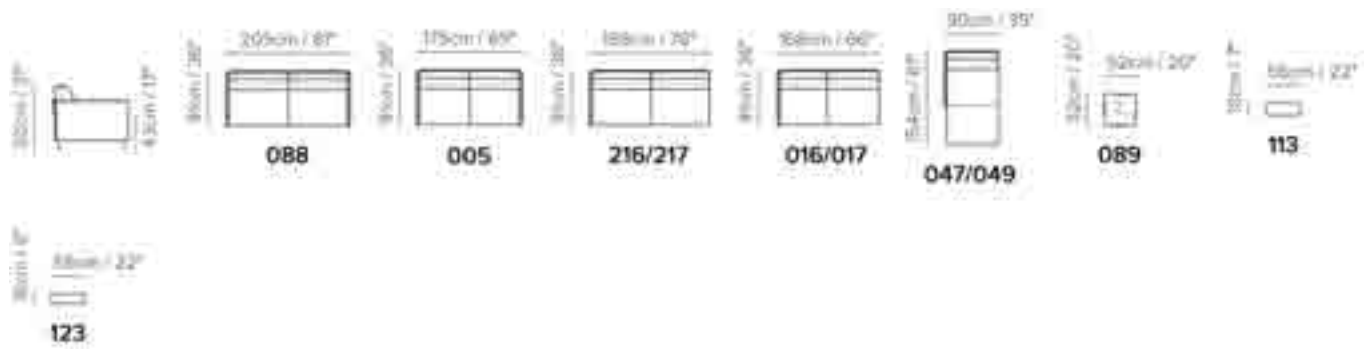

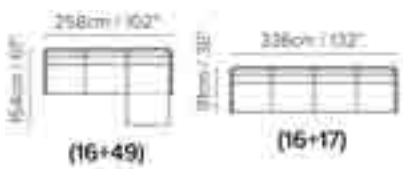

## SCHEMATICS



## COMPOSITION EXAMPLES



## TECHNICAL INFORMATION

	<b>COVERING</b>	Mix <input checked="" type="checkbox"/>	Leather <input checked="" type="checkbox"/>	Soft Cover <input checked="" type="checkbox"/>		
	<b>LEGS</b>	Wood <input type="checkbox"/>	Metal <input checked="" type="checkbox"/>	Plastic <input type="checkbox"/>	Castors <input type="checkbox"/>	Upholstered <input type="checkbox"/>
	<b>FILLING</b>	Arms <input type="checkbox"/> Fiber <input checked="" type="checkbox"/> Foam <input type="checkbox"/> Feather/Fiber Mix <input type="checkbox"/> Feather	Seat cushion <input type="checkbox"/> Fiber <input checked="" type="checkbox"/> Foam <input type="checkbox"/> Feather/Fiber Mix <input type="checkbox"/> Feather	Back cushion <input type="checkbox"/> Fiber <input checked="" type="checkbox"/> Foam <input type="checkbox"/> Feather/Fiber Mix <input type="checkbox"/> Feather		
	<b>COMFORT</b>	Standard Comfort <input checked="" type="checkbox"/>	Firm Comfort <input checked="" type="checkbox"/>			
	<b>FUNCTION</b>	Bed <input type="checkbox"/>	Electric motion <input type="checkbox"/>	Motion <input type="checkbox"/>	Recliner <input type="checkbox"/>	Sliding <input type="checkbox"/>
	<b>OPTIONS</b>	Contrast Stitching <input checked="" type="checkbox"/>	Removable <input type="checkbox"/>	Nails <input type="checkbox"/>		

## NOTES

- Model is characterized by decorative "mocassin" stitching.
- For this model all leathers are available with contrast stitching. If you choose contrast, the stitching is always taupe. If you don't choose contrast, the stitching is tone-on-tone.
- Seat cushion includes a layer of memory foam, a pressure-sensitive soft polyurethane, that recovers its form completely thus giving great comfort
- Tight Seat Cushion (the seat cushions of the models are fixed to the frame)
- With Leather Side (the sectional pieces come with leather sides)
- Wood Frame
- Without Feet Assembled (the feet will be in a bag inside the package)
- Plastic Wrap (the model will be wrapped in a plastic bag)
- Feet available in metal finishing 75 (Glazed Nickel)
- Feet height 16,5 cm
- LEATHER-FABRIC MIX COVERING OPTIONS:
- 1° COV. (Leather) = Frame and arms
- 2° COV. (Fabric) = Seat and back cushions
- In fabric and mix, the stitching is always taupe. There is no other option.

NOTES

---





■ vers. 272 + 291 + 274



■ vers. 272 + 291 + 049 + 113



■ vers. 272 + 291 + 049





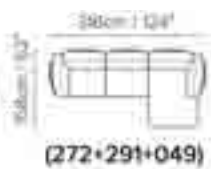
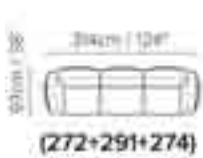

## SCHEMATICS



## COMPOSITION EXAMPLES



## TECHNICAL INFORMATION

	<b>COVERING</b>	Mix <input checked="" type="checkbox"/>	Leather <input checked="" type="checkbox"/>	Soft Cover <input checked="" type="checkbox"/>		
	<b>LEGS</b>	Wood <input type="checkbox"/>	Metal <input checked="" type="checkbox"/>	Plastic <input type="checkbox"/>	Castors <input type="checkbox"/>	Upholstered <input type="checkbox"/>
	<b>FILLING</b>	Arms <input type="checkbox"/> Fiber <input checked="" type="checkbox"/> Foam <input type="checkbox"/> Feather/Fiber Mix <input type="checkbox"/> Feather	Seat cushion <input type="checkbox"/> Fiber <input checked="" type="checkbox"/> Foam <input type="checkbox"/> Feather/Fiber Mix <input type="checkbox"/> Feather	Back cushion <input type="checkbox"/> Fiber <input checked="" type="checkbox"/> Foam <input type="checkbox"/> Feather/Fiber Mix <input type="checkbox"/> Feather		
	<b>COMFORT</b>	Standard Comfort <input checked="" type="checkbox"/>	Firm Comfort <input type="checkbox"/>			
	<b>FUNCTION</b>	Bed <input type="checkbox"/>	Electric motion <input type="checkbox"/>	Motion <input type="checkbox"/>	Recliner <input type="checkbox"/>	Sliding <input type="checkbox"/>
	<b>OPTIONS</b>	Nails <input type="checkbox"/>	Removable <input type="checkbox"/>	Contrast Stitching <input type="checkbox"/>		

## NOTES

- Model also available with thick leather with model code Sxxx (Art. Vesuvio, Cassidy).
- Loose Seat Cushion (the seat cushions of the model are not fixed to the frame)
- Back Cushion Zippered (the back cushion is attached to the frame through a zipper)
- Arm Cushion Zippered (the arm cushion is attached to the frame through a zipper)
- With Leather Side (the sectional pieces come with leather sides)
- Wood Frame
- With Feet Assembled (the model will be loaded with feet already mounted on the sofa)
- Plastic Wrap (the model will be wrapped in a plastic bag)
- Feet available in metal finishing 78 (Glossy Black)
- Feet height 12,0 cm
- Standard versions are available up to cat. 35 and 3B.
- Second option versions are available starting from cat. 40 and 4A.
- Second option versions are characterized by a special «live cut stitching» (cut pinched stitching).
- LEATHER-FABRIC MIX COVERING OPTIONS:
- 1° COV. (Leather) = Frame
- 2° COV. (Fabric) = Arms, seat and back cushions

NOTES

---



■ vers. 066



■ vers. 066







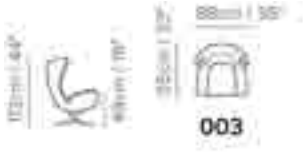

■ vers. 066

## SCHEMATICS

---



## TECHNICAL INFORMATION

	<b>COVERING</b>	Leather <input checked="" type="checkbox"/>	Soft Cover <input checked="" type="checkbox"/>				
	<b>LEGS</b>	Wood <input type="checkbox"/>	Metal <input checked="" type="checkbox"/>	Plastic <input type="checkbox"/>	Castors <input type="checkbox"/>	Upholstered <input type="checkbox"/>	
	<b>FILLING</b>	Arms <input type="checkbox"/>	Fiber <input type="checkbox"/> Foam <input type="checkbox"/> Feather/Fiber Mix <input type="checkbox"/> Feather <input type="checkbox"/>	Seat cushion <input type="checkbox"/>	Fiber <input type="checkbox"/> Foam <input type="checkbox"/> Feather/Fiber Mix <input type="checkbox"/> Feather <input type="checkbox"/>	Back cushion <input type="checkbox"/>	Fiber <input type="checkbox"/> Foam <input type="checkbox"/> Feather/Fiber Mix <input type="checkbox"/> Feather <input type="checkbox"/>
	<b>COMFORT</b>	Standard Comfort <input checked="" type="checkbox"/>	Firm Comfort <input type="checkbox"/>				
	<b>FUNCTION</b>	Bed <input type="checkbox"/>	Electric motion <input type="checkbox"/>	Motion <input type="checkbox"/>	Recliner <input type="checkbox"/>	Sliding <input type="checkbox"/>	
	<b>OPTIONS</b>	Contrast Stitching <input type="checkbox"/>	Removable <input type="checkbox"/>	Nails <input type="checkbox"/>			

## NOTES

- Vers. 003 has swivel base and is without speakers.
- Seat cushion includes a layer of memory foam, a pressure-sensitive soft polyurethane, that recovers its form completely thus giving great comfort
- Loose Seat Cushion (the seat cushions of the model are not fixed to the frame)
- Tight Back Cushion (the back cushions of the models are fixed to the frame)
- Metal Frame
- With Feet Assembled (the model will be loaded with feet already mounted on the sofa)
- Plastic Wrap (the model will be wrapped in a plastic bag)
- Metal base available in finishing 75 (Glazed Nickel)

NOTES

---





■ vers. 064



■ vers. 005







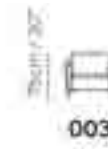
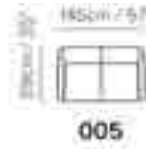
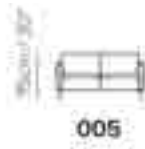
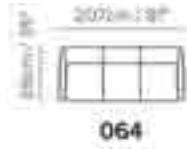
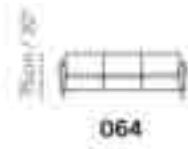

■ vers. 003

### SCHEMATICS

---



## TECHNICAL INFORMATION

	<b>COVERING</b>	Leather <input checked="" type="checkbox"/>	Soft Cover <input checked="" type="checkbox"/>			
	<b>LEGS</b>	Wood <input type="checkbox"/>	Metal <input checked="" type="checkbox"/>	Plastic <input type="checkbox"/>	Castors <input type="checkbox"/>	Upholstered <input type="checkbox"/>
	<b>FILLING</b>	Arms <input type="checkbox"/> Fiber <input checked="" type="checkbox"/> Foam <input type="checkbox"/> Feather/Fiber Mix <input type="checkbox"/> Feather	Seat cushion <input type="checkbox"/> Fiber <input checked="" type="checkbox"/> Foam <input type="checkbox"/> Feather/Fiber Mix <input type="checkbox"/> Feather	Back cushion <input type="checkbox"/> Fiber <input checked="" type="checkbox"/> Foam <input type="checkbox"/> Feather/Fiber Mix <input type="checkbox"/> Feather		
	<b>COMFORT</b>	Standard Comfort <input checked="" type="checkbox"/>	Firm Comfort <input type="checkbox"/>			
	<b>FUNCTION</b>	Bed <input type="checkbox"/>	Electric motion <input type="checkbox"/>	Motion <input type="checkbox"/>	Recliner <input type="checkbox"/>	Sliding <input type="checkbox"/>
	<b>OPTIONS</b>	Nails <input type="checkbox"/>	Removable <input type="checkbox"/>	Contrast Stitching <input checked="" type="checkbox"/>		

## NOTES

- For this model all coverings are available with contrast stitching. If you choose contrast, the stitching is always taupe. If you don't choose contrast, the stitching is tone-on-tone.
- Tight Seat Cushion (the seat cushions of the models are fixed to the frame)
- Tight Back Cushion (the back cushions of the models are fixed to the frame)
- Wood Frame
- Without Feet Assembled (the feet will be in a bag inside the package)
- Plastic Wrap (the model will be wrapped in a plastic bag)
- Feet available in metal finishings 77 (Glossy Chromed) / 78 (Glossy Black)
- Feet height 15,0 cm

NOTES

---



■ vers. 000 + 001 + 002



■ vers. 000 + 002



■ vers. 000 + 001 + 049



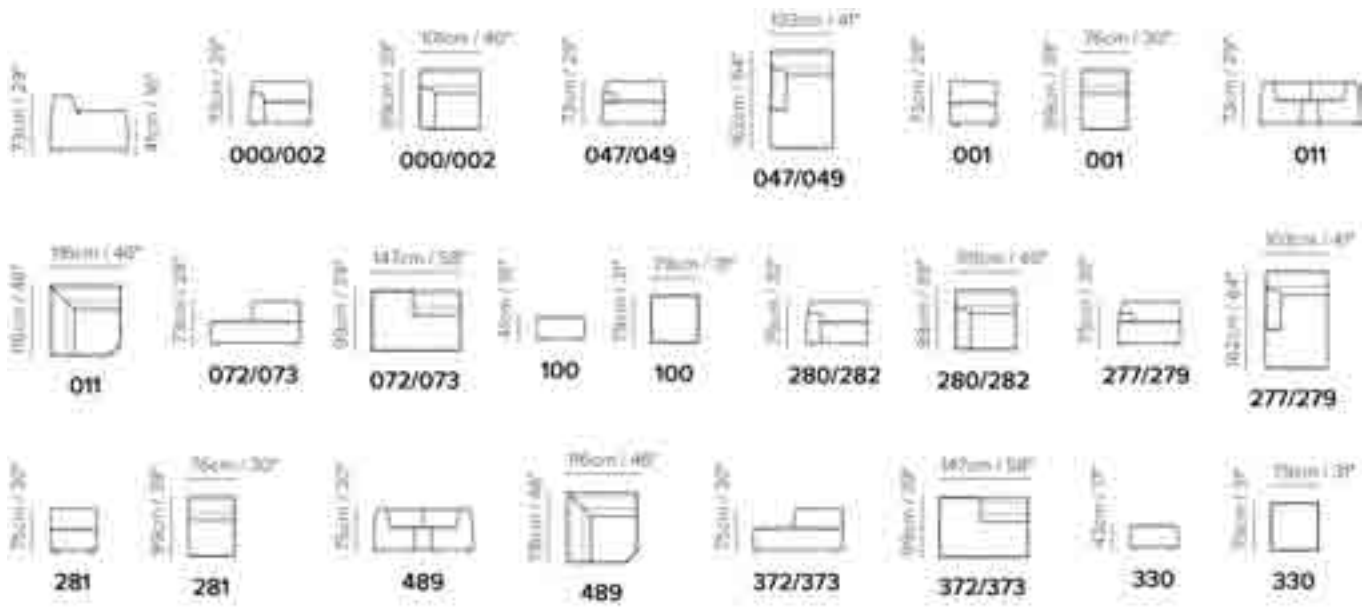

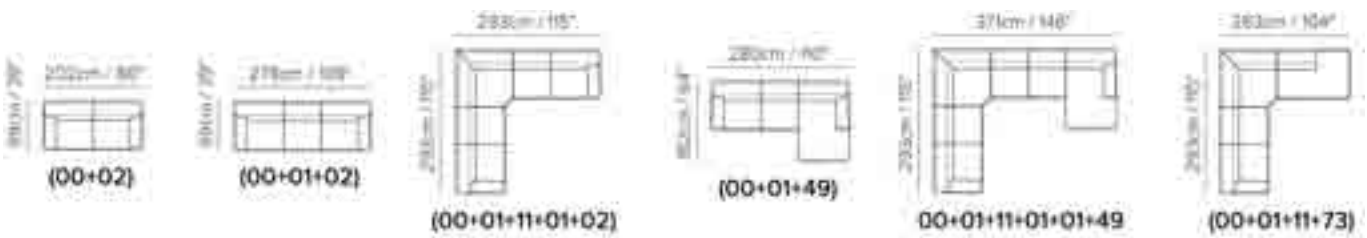

## SCHEMATICS



## COMPOSITION EXAMPLES



## TECHNICAL INFORMATION

	<b>COVERING</b>	Leather <input checked="" type="checkbox"/>	Soft Cover <input checked="" type="checkbox"/>			
	<b>LEGS</b>	Wood <input type="checkbox"/>	Metal <input type="checkbox"/>	Plastic <input checked="" type="checkbox"/>	Castors <input type="checkbox"/>	Upholstered <input type="checkbox"/>
	<b>FILLING</b>	Arms <input checked="" type="checkbox"/> Fiber <input checked="" type="checkbox"/> Foam <input type="checkbox"/> Feather/Fiber Mix <input type="checkbox"/> Feather	Seat cushion <input type="checkbox"/> Fiber <input checked="" type="checkbox"/> Foam <input type="checkbox"/> Feather/Fiber Mix <input type="checkbox"/> Feather	Back cushion <input checked="" type="checkbox"/> Fiber <input checked="" type="checkbox"/> Foam <input type="checkbox"/> Feather/Fiber Mix <input type="checkbox"/> Feather		
	<b>COMFORT</b>	Standard Comfort <input checked="" type="checkbox"/>	Firm Comfort <input type="checkbox"/>			
	<b>FUNCTION</b>	Bed <input type="checkbox"/>	Electric motion <input type="checkbox"/>	Motion <input type="checkbox"/>	Recliner <input type="checkbox"/>	Sliding <input type="checkbox"/>
	<b>OPTIONS</b>	Contrast Stitching <input type="checkbox"/>	Removable <input type="checkbox"/>	Nails <input type="checkbox"/>		

## NOTES

- Model is available with contrast welt to be entered as second covering
- Seat cushion includes a layer of memory foam, a pressure-sensitive soft polyurethane, that recovers its form completely thus giving great comfort
- Second option versions have soft comfort (memory foam) and its height is 2 cm more than standard versions
- Tight Seat Cushion (the seat cushions of the models are fixed to the frame)
- Tight Back Cushion (the back cushions of the models are fixed to the frame)
- With Leather Side (the sectional pieces come with leather sides)
- Wood Frame
- Without Feet Assembled (the feet will be in a bag inside the package)
- Plastic Wrap (the model will be wrapped in a plastic bag)
- Feet height 5,0 cm

NOTES

---





■ vers. 009



■ vers. 016 + 481



■ vers. 016 + 481



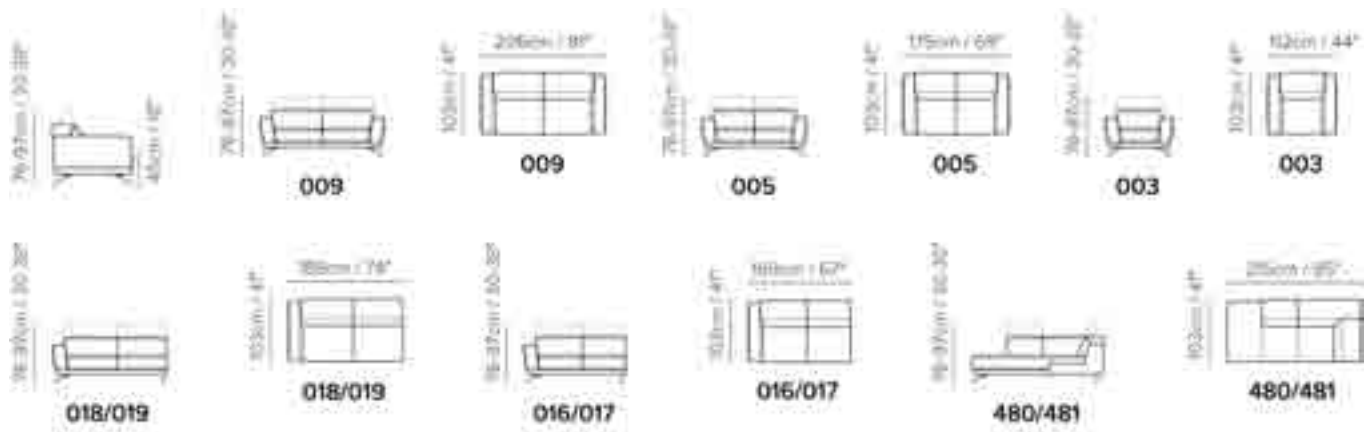



## SCHEMATICS



## COMPOSITION EXAMPLES



## TECHNICAL INFORMATION

	<b>COVERING</b>	Leather <input checked="" type="checkbox"/>	Soft Cover <input checked="" type="checkbox"/>			
	<b>LEGS</b>	Wood <input type="checkbox"/>	Metal <input checked="" type="checkbox"/>	Plastic <input type="checkbox"/>	Castors <input type="checkbox"/>	Upholstered <input type="checkbox"/>
	<b>FILLING</b>	Arms <input type="checkbox"/> Fiber <input checked="" type="checkbox"/> Foam <input type="checkbox"/> Feather/Fiber Mix <input type="checkbox"/> Feather	Seat cushion <input type="checkbox"/> Fiber <input checked="" type="checkbox"/> Foam <input type="checkbox"/> Feather/Fiber Mix <input type="checkbox"/> Feather	Back cushion <input type="checkbox"/> Fiber <input checked="" type="checkbox"/> Foam <input type="checkbox"/> Feather/Fiber Mix <input type="checkbox"/> Feather		
	<b>COMFORT</b>	Standard Comfort <input checked="" type="checkbox"/>	Firm Comfort <input type="checkbox"/>			
	<b>FUNCTION</b>	Bed <input type="checkbox"/>	Electric motion <input type="checkbox"/>	Motion <input type="checkbox"/>	Recliner <input type="checkbox"/>	Sliding <input type="checkbox"/>
	<b>OPTIONS</b>	Nails <input type="checkbox"/>	Removable <input type="checkbox"/>	Contrast Stitching <input checked="" type="checkbox"/>		

## NOTES

- For this model all leathers are available with contrast stitching. If you choose contrast, the stitching is always taupe. If you don't choose contrast, the stitching is tone-on-tone.
- Adjustable headrest on all versions.
- Versions 480/481 have terminal seats with adjustable backrests.
- Tight Seat Cushion (the seat cushions of the models are fixed to the frame)
- Tight Back Cushion (the back cushions of the models are fixed to the frame)
- No Leather Side (the sectional pieces have the side covered with fabric and not leather)
- Wood Frame
- Without Feet Assembled (the feet will be in a bag inside the package)
- Plastic Wrap (the model will be wrapped in a plastic bag)
- Feet available in metal finishing 75 (Glazed Nickel)
- Feet height 14,0 cm

NOTES

---



■ vers. 446



■ vers. 446



■ vers. 480 + 183



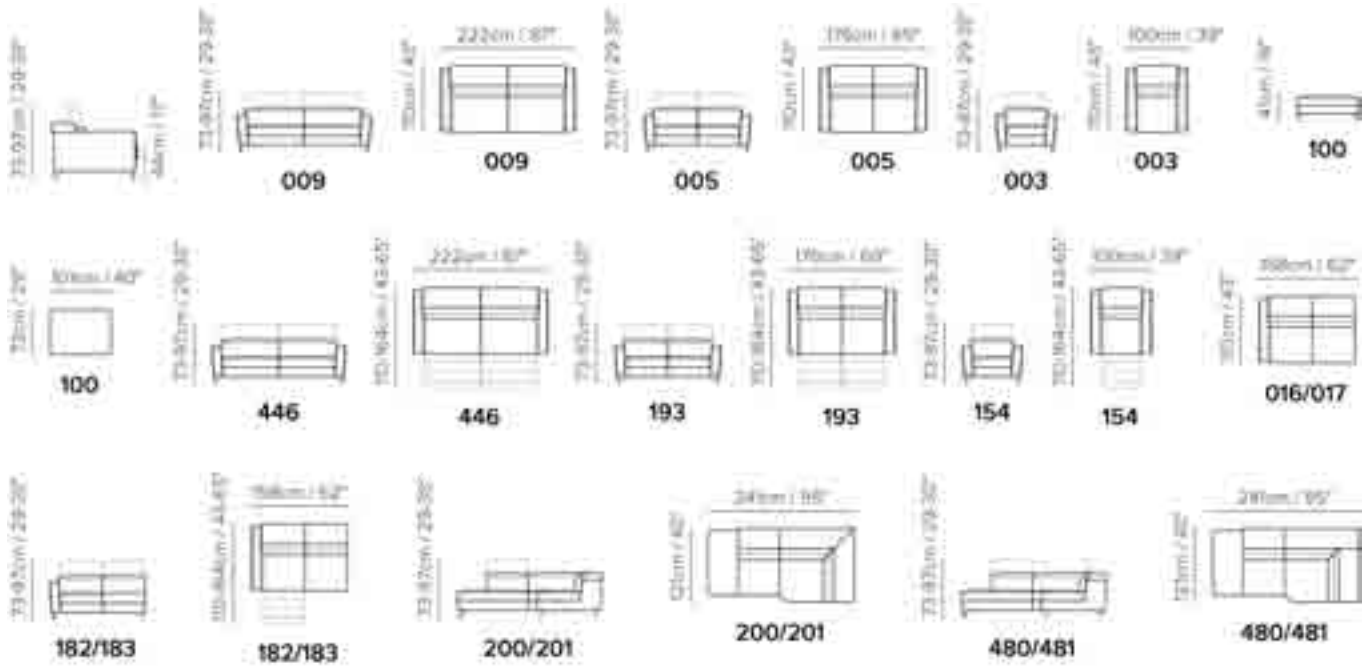



## SCHEMATICS



## COMPOSITION EXAMPLES



## TECHNICAL INFORMATION

	<b>COVERING</b>	Leather <input checked="" type="checkbox"/>	Soft Cover <input checked="" type="checkbox"/>			
	<b>LEGS</b>	Wood <input type="checkbox"/>	Metal <input checked="" type="checkbox"/>	Plastic <input type="checkbox"/>	Castors <input type="checkbox"/>	Upholstered <input type="checkbox"/>
	<b>FILLING</b>	Arms <input type="checkbox"/> Fiber <input checked="" type="checkbox"/> Foam <input type="checkbox"/> Feather/Fiber Mix <input type="checkbox"/> Feather	Seat cushion <input type="checkbox"/> Fiber <input checked="" type="checkbox"/> Foam <input type="checkbox"/> Feather/Fiber Mix <input type="checkbox"/> Feather	Back cushion <input type="checkbox"/> Fiber <input checked="" type="checkbox"/> Foam <input type="checkbox"/> Feather/Fiber Mix <input type="checkbox"/> Feather		
	<b>COMFORT</b>	Standard Comfort <input checked="" type="checkbox"/>	Firm Comfort <input checked="" type="checkbox"/>			
	<b>FUNCTION</b>	Bed <input type="checkbox"/>	Electric motion <input checked="" type="checkbox"/>	Motion <input type="checkbox"/>	Recliner <input checked="" type="checkbox"/>	Sliding <input type="checkbox"/>
	<b>OPTIONS</b>	Contrast Stitching <input checked="" type="checkbox"/>	Removable <input type="checkbox"/>	Nails <input type="checkbox"/>		

## NOTES

- Contrast stitching is available only with certain covers and option is managed directly in NARES.
- Adjustable headrest on all versions.
- Versions 200/201 have terminal seats with fixed backrests.
- Versions 480/481 have terminal seats with adjustable backrests.
- Seat cushion includes a layer of memory foam, a pressure-sensitive soft polyurethane, that recovers its form completely thus giving great comfort
- Tight Seat Cushion (the seat cushions of the models are fixed to the frame)
- Tight Back Cushion (the back cushions of the models are fixed to the frame)
- No Leather Side (the sectional pieces have the side covered with fabric and not leather)
- Wood Frame
- Without Feet Assembled (the feet will be in a bag inside the package)
- Plastic Wrap (the model will be wrapped in a plastic bag)
- Feet available in metal finishing 77 (Glossy Chromed)
- Feet height 11,0 cm

NOTES

---





■ vers.009



■ vers. 047 + 274



■ vers. 264



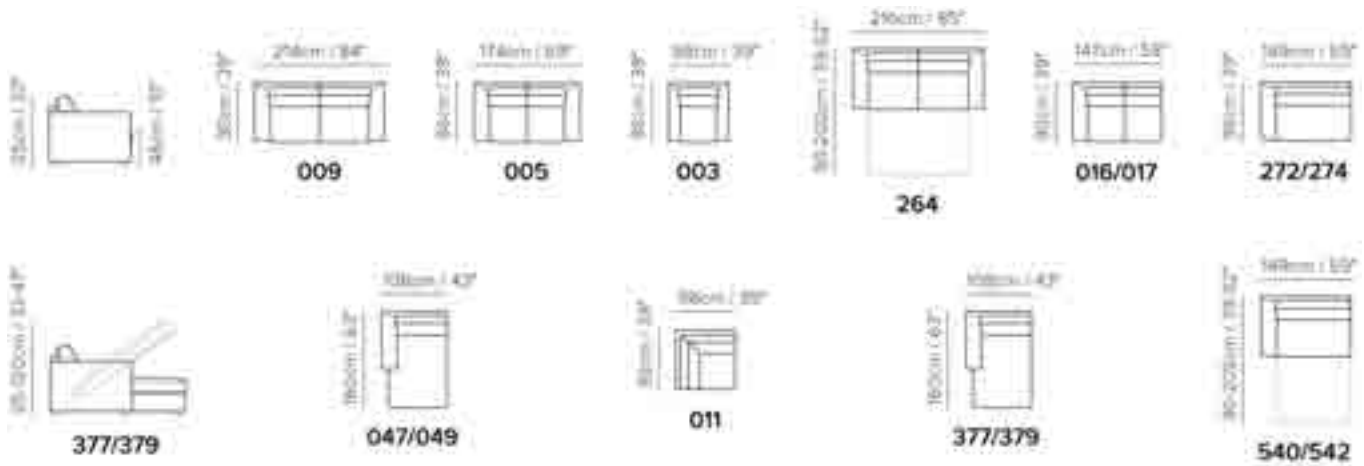



## SCHEMATICS



## COMPOSITION EXAMPLES



## TECHNICAL INFORMATION

	<b>COVERING</b>	Leather <input checked="" type="checkbox"/>	Soft Cover <input checked="" type="checkbox"/>			
	<b>LEGS</b>	Wood <input type="checkbox"/>	Metal <input type="checkbox"/>	Plastic <input checked="" type="checkbox"/>	Castors <input type="checkbox"/>	Upholstered <input type="checkbox"/>
	<b>FILLING</b>	Arms <input type="checkbox"/> Fiber <input checked="" type="checkbox"/> Foam <input type="checkbox"/> Feather/Fiber Mix <input type="checkbox"/> Feather	Seat cushion <input type="checkbox"/> Fiber <input checked="" type="checkbox"/> Foam <input type="checkbox"/> Feather/Fiber Mix <input type="checkbox"/> Feather	Back cushion <input type="checkbox"/> Fiber <input checked="" type="checkbox"/> Foam <input type="checkbox"/> Feather/Fiber Mix <input type="checkbox"/> Feather		
	<b>COMFORT</b>	Standard Comfort <input checked="" type="checkbox"/>	Firm Comfort <input checked="" type="checkbox"/>			
	<b>FUNCTION</b>	Bed <input checked="" type="checkbox"/>	Electric motion <input type="checkbox"/>	Motion <input type="checkbox"/>	Recliner <input type="checkbox"/>	Sliding <input type="checkbox"/>
	<b>OPTIONS</b>	Nails <input type="checkbox"/>	Removable <input type="checkbox"/>	Contrast Stitching <input type="checkbox"/>		

## BED MECHANISM & MATTRESS

MECHANISM		MATTRESS		
VERSIONS	TYPE	VERSIONS	TYPE	DIMENSIONS
				W L H
540,542	Ready-Bed electro-welded - Double folding	540,542	GREENPLUS	100 193 14
264	Ready-Bed electro-welded - Double folding	264	GREENPLUS	140 193 14

**Ready-Bed electro-welded**  
**GREENPLUS**

The back cushion goes under the bed mechanism which contains a set of pillow holder.

GREENPLUS mattress is a patented, innovative product. It is ecological, made up of microporous elastomers. It has a great adaptation capacity to the various body pressure which gives big support to the spine. It is antibacterial and no-allergic.

## NOTES

- Model is available with contrast welt to be entered as second covering
- Tight Seat Cushion (the seat cushions of the models are fixed to the frame)
- No Leather Side (the sectional pieces have the side covered with fabric and not leather)
- Wood Frame
- Without Feet Assembled (the feet will be in a bag inside the package)
- Plastic Wrap (the model will be wrapped in a plastic bag)
- Feet height 4,0 cm

NOTES

---



■ vers. 009



■ vers. 018 + 481



■ vers. 016 + 049



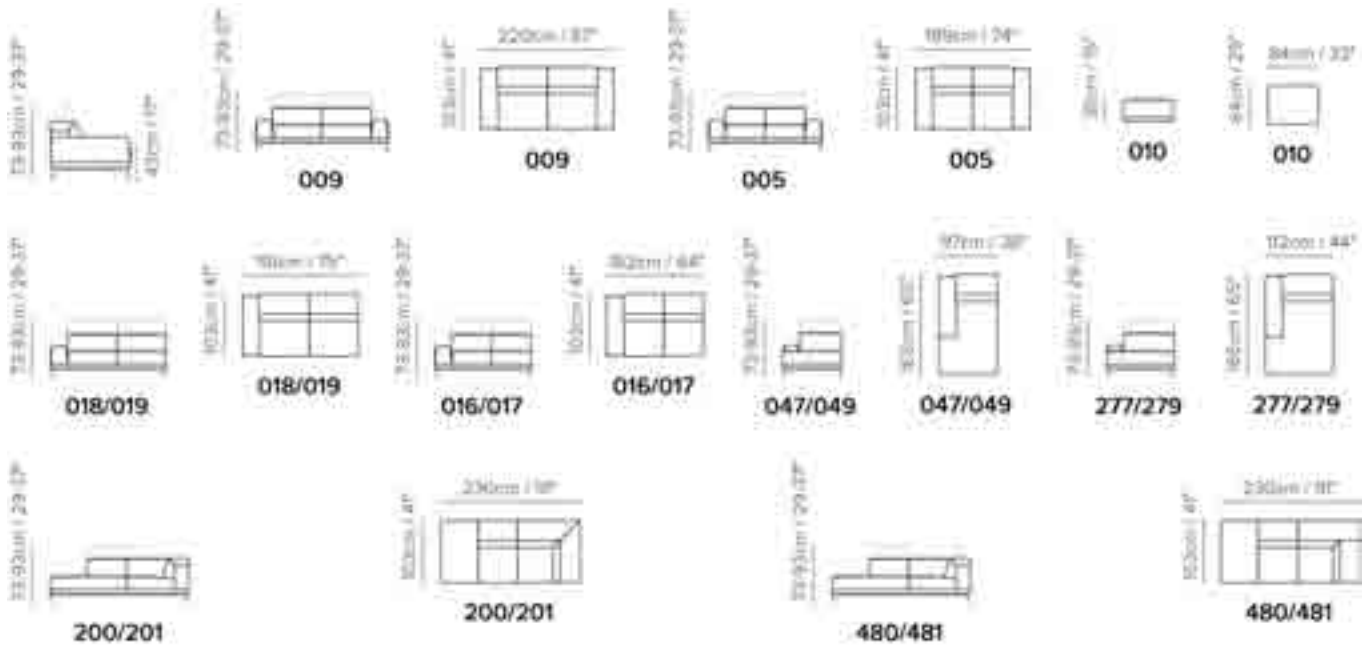



## SCHEMATICS



## COMPOSITION EXAMPLES



## TECHNICAL INFORMATION

	<b>COVERING</b>	Leather <input checked="" type="checkbox"/>	Soft Cover <input checked="" type="checkbox"/>			
	<b>LEGS</b>	Wood <input checked="" type="checkbox"/>	Metal <input type="checkbox"/>	Plastic <input type="checkbox"/>	Castors <input type="checkbox"/>	Upholstered <input type="checkbox"/>
	<b>FILLING</b>	Arms <input type="checkbox"/> Fiber <input checked="" type="checkbox"/> Foam <input type="checkbox"/> Feather/Fiber Mix <input type="checkbox"/> Feather	Seat cushion <input type="checkbox"/> Fiber <input checked="" type="checkbox"/> Foam <input type="checkbox"/> Feather/Fiber Mix <input type="checkbox"/> Feather	Back cushion <input type="checkbox"/> Fiber <input checked="" type="checkbox"/> Foam <input type="checkbox"/> Feather/Fiber Mix <input type="checkbox"/> Feather		
	<b>COMFORT</b>	Standard Comfort <input checked="" type="checkbox"/>	Firm Comfort <input type="checkbox"/>			
	<b>FUNCTION</b>	Bed <input type="checkbox"/>	Electric motion <input type="checkbox"/>	Motion <input type="checkbox"/>	Recliner <input type="checkbox"/>	Sliding <input type="checkbox"/>
	<b>OPTIONS</b>	Contrast Stitching <input type="checkbox"/>	Removable <input type="checkbox"/>	Nails <input type="checkbox"/>		

## NOTES

- Adjustable headrest on all versions.
- Versions 200/201 have terminal seats with fixed backrests.
- Versions 480/481 have terminal seats with adjustable backrests.
- Seat cushion includes a layer of memory foam, a pressure-sensitive soft polyurethane, that recovers its form completely thus giving great comfort
- Tight Seat Cushion (the seat cushions of the models are fixed to the frame)
- Tight Back Cushion (the back cushions of the models are fixed to the frame)
- With Leather Side (the sectional pieces come with leather sides)
- Wood Frame
- Without Feet Assembled (the feet will be in a bag inside the package)
- Plastic Wrap (the model will be wrapped in a plastic bag)
- Feet available in wood finishing 18 (Wengè)
- Feet height 16,0 cm

NOTES

---





■ vers. 446



■ vers. 193



■ vers. 188 + 183



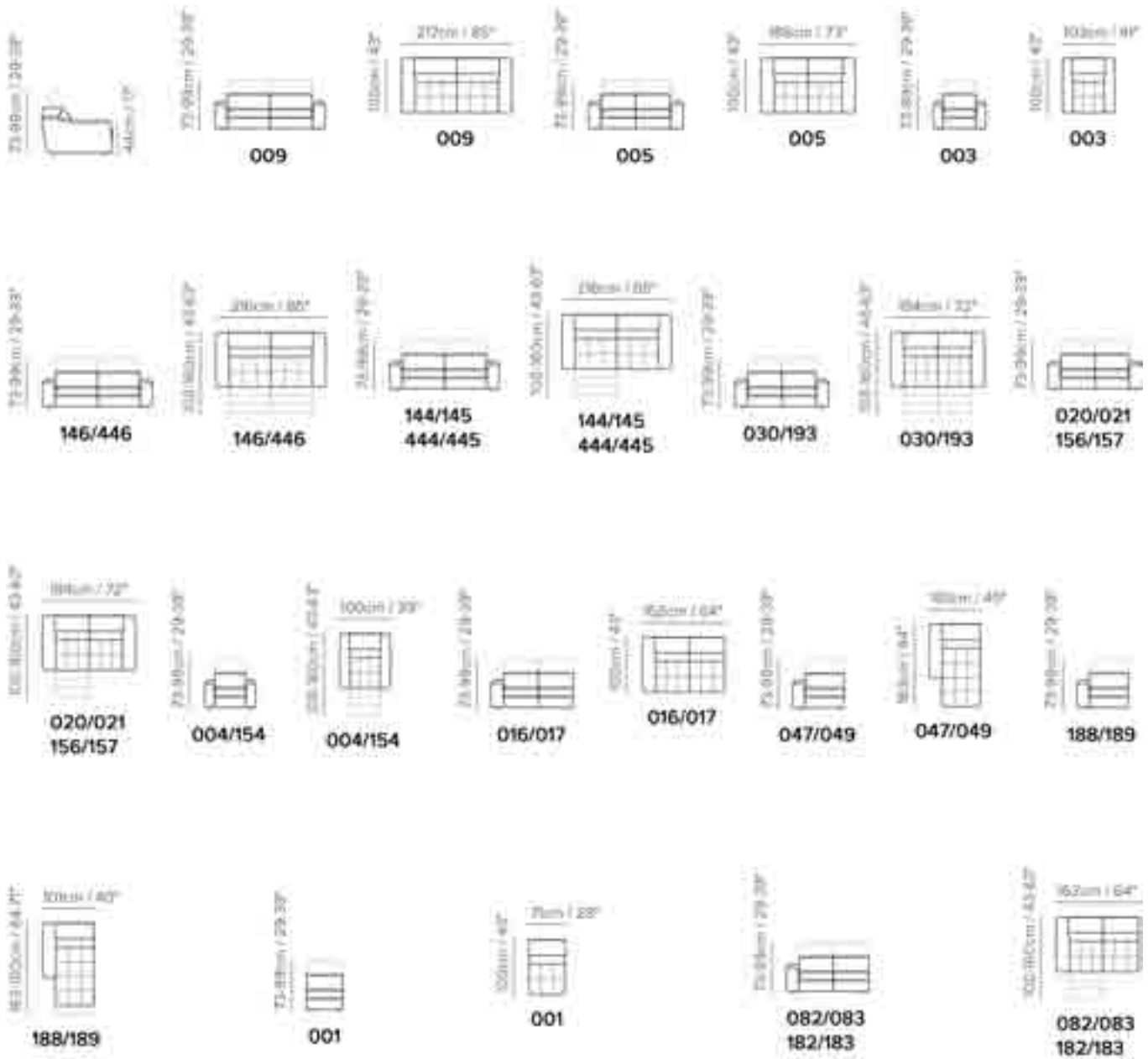



## SCHEMATICS



## COMPOSITION EXAMPLES



## TECHNICAL INFORMATION

	<b>COVERING</b>	Leather <input checked="" type="checkbox"/>	Soft Cover <input checked="" type="checkbox"/>			
	<b>LEGS</b>	Wood <input type="checkbox"/>	Metal <input type="checkbox"/>	Plastic <input checked="" type="checkbox"/>	Castors <input type="checkbox"/>	Upholstered <input type="checkbox"/>
	<b>FILLING</b>	Arms <input type="checkbox"/> Fiber <input checked="" type="checkbox"/> Foam <input type="checkbox"/> Feather/Fiber Mix <input type="checkbox"/> Feather	Seat cushion <input type="checkbox"/> Fiber <input checked="" type="checkbox"/> Foam <input type="checkbox"/> Feather/Fiber Mix <input type="checkbox"/> Feather	Back cushion <input type="checkbox"/> Fiber <input checked="" type="checkbox"/> Foam <input type="checkbox"/> Feather/Fiber Mix <input type="checkbox"/> Feather		
	<b>COMFORT</b>	Standard Comfort <input checked="" type="checkbox"/>	Firm Comfort <input checked="" type="checkbox"/>			
	<b>FUNCTION</b>	Bed <input type="checkbox"/>	Electric motion <input checked="" type="checkbox"/>	Motion <input checked="" type="checkbox"/>	Recliner <input checked="" type="checkbox"/>	Sliding <input type="checkbox"/>
	<b>OPTIONS</b>	Nails <input type="checkbox"/>	Removable <input type="checkbox"/>	Contrast Stitching <input type="checkbox"/>		

## NOTES

- Adjustable headrest on all versions.
- Tight Seat Cushion (the seat cushions of the models are fixed to the frame)
- Tight Back Cushion (the back cushions of the models are fixed to the frame)
- No Leather Side (the sectional pieces have the side covered with fabric and not leather)
- Wood Frame
- Without Feet Assembled (the feet will be in a bag inside the package)
- Plastic Wrap (the model will be wrapped in a plastic bag)
- Feet height 4,0 cm
- In leather, the model has quilting on the seat cushion.

NOTES

---



■ vers. 446



■ vers. 446



■ vers. 182 + 049



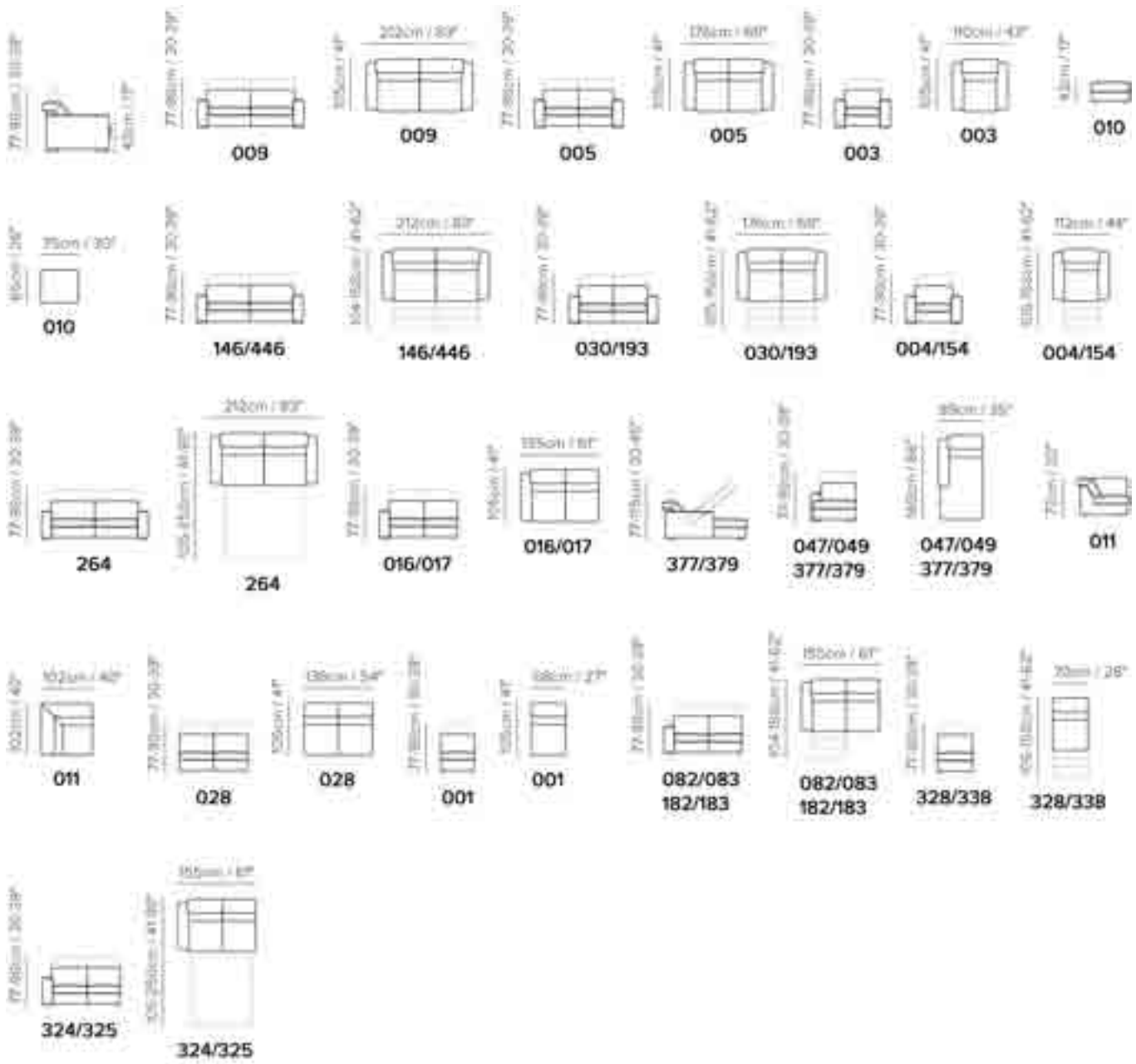



## SCHEMATICS



## COMPOSITION EXAMPLES



## TECHNICAL INFORMATION

	<b>COVERING</b>	Leather <input checked="" type="checkbox"/>	Soft Cover <input checked="" type="checkbox"/>			
	<b>LEGS</b>	Wood <input checked="" type="checkbox"/>	Metal <input type="checkbox"/>	Plastic <input type="checkbox"/>	Castors <input type="checkbox"/>	Upholstered <input type="checkbox"/>
	<b>FILLING</b>	Arms <input type="checkbox"/> Fiber <input checked="" type="checkbox"/> Foam <input type="checkbox"/> Feather/Fiber Mix <input type="checkbox"/> Feather	Seat cushion <input type="checkbox"/> Fiber <input checked="" type="checkbox"/> Foam <input type="checkbox"/> Feather/Fiber Mix <input type="checkbox"/> Feather	Back cushion <input type="checkbox"/> Fiber <input checked="" type="checkbox"/> Foam <input type="checkbox"/> Feather/Fiber Mix <input type="checkbox"/> Feather		
	<b>COMFORT</b>	Standard Comfort <input checked="" type="checkbox"/>	Firm Comfort <input checked="" type="checkbox"/>			
	<b>FUNCTION</b>	Bed <input checked="" type="checkbox"/>	Electric motion <input checked="" type="checkbox"/>	Motion <input checked="" type="checkbox"/>	Recliner <input checked="" type="checkbox"/>	Sliding <input type="checkbox"/>
	<b>OPTIONS</b>	Contrast Stitching <input type="checkbox"/>	Removable <input type="checkbox"/>	Nails <input type="checkbox"/>		

## BED MECHANISM & MATTRESS

MECHANISM		MATTRESS		
VERSIONS	TYPE	VERSIONS	TYPE	DIMENSIONS
				W L H
324,325	Transformable electro-welded - Double folding	324,325	GREENPLUS	100 190 12
264	Transformable electro-welded - Double folding	264	GREENPLUS	140 193 12

**Transformable electro-welded GREENPLUS**

The back cushion remains fixed at the head, creating a comfortable support.

GREENPLUS mattress is a patented, innovative product. It is ecological, made up of microporous elastomers. It has a great adaptation capacity to the various body pressure which gives big support to the spine. It is antibacterial and no-allergic.

## NOTES

- Adjustable headrest on all versions.
- Model is available with contrast welt to be entered as second covering
- Tight Seat Cushion (the seat cushions of the models are fixed to the frame)
- Tight Back Cushion (the back cushions of the models are fixed to the frame)
- No Leather Side (the sectional pieces have the side covered with fabric and not leather)
- Wood Frame
- Without Feet Assembled (the feet will be in a bag inside the package)
- Plastic Wrap (the model will be wrapped in a plastic bag)
- Feet available in wood finishings 09 (Walnut) / 18 (Wengè)
- Feet height 4,5 cm

NOTES

---





■ vers. 239



■ vers. 239







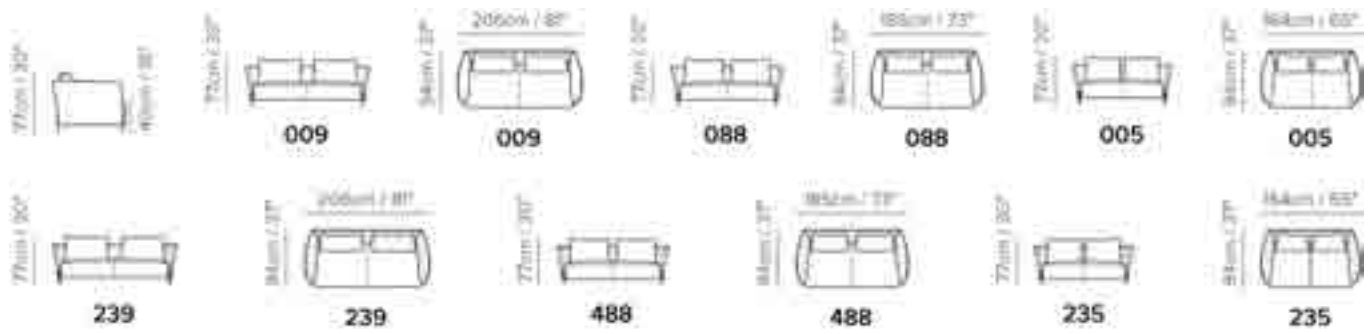

■ vers. 239

## SCHEMATICS



## TECHNICAL INFORMATION

	<b>COVERING</b>	Soft Cover <input checked="" type="checkbox"/>					
	<b>LEGS</b>	Wood <input type="checkbox"/>	Metal <input checked="" type="checkbox"/>	Plastic <input type="checkbox"/>	Castors <input type="checkbox"/>	Upholstered <input type="checkbox"/>	
	<b>FILLING</b>	Arms	<input type="checkbox"/> Fiber <input checked="" type="checkbox"/> Foam <input type="checkbox"/> Feather/Fiber Mix <input type="checkbox"/> Feather	Seat cushion	<input type="checkbox"/> Fiber <input checked="" type="checkbox"/> Foam <input type="checkbox"/> Feather/Fiber Mix <input type="checkbox"/> Feather	Back cushion	<input type="checkbox"/> Fiber <input type="checkbox"/> Foam <input type="checkbox"/> Feather/Fiber Mix <input checked="" type="checkbox"/> Feather
	<b>COMFORT</b>	Standard Comfort <input checked="" type="checkbox"/>	Firm Comfort <input type="checkbox"/>				
	<b>FUNCTION</b>	Bed <input type="checkbox"/>	Electric motion <input type="checkbox"/>	Motion <input type="checkbox"/>	Recliner <input type="checkbox"/>	Sliding <input type="checkbox"/>	
	<b>OPTIONS</b>	Nails <input type="checkbox"/>	Removable <input type="checkbox"/>	Contrast Stitching <input type="checkbox"/>			

## NOTES

- Seat cushion includes a layer of memory foam, a pressure-sensitive soft polyurethane, that recovers its form completely thus giving great comfort
- Tight Seat Cushion (the seat cushions of the models are fixed to the frame)
- Wood Frame
- With Feet Assembled (the model will be loaded with feet already mounted on the sofa)
- Plastic Wrap (the model will be wrapped in a plastic bag)
- Feet available in metal finishings 77 (Glossy Chromed) / 78 (Glossy Black)
- Feet height 11,5 cm
- Second option versions are tufted on the inside part on arm and back panel
- TWO TONE COVERING OPTIONS IN FABRIC:
- 1° COV. = Frame and arms
- 2° COV. = Welt, seat and back cushions

NOTES

---



■ vers. 003



■ vers. 003









■ vers. 003

## SCHEMATICS

---



## TECHNICAL INFORMATION

	<b>COVERING</b>	Leather <input checked="" type="checkbox"/>	Soft Cover <input checked="" type="checkbox"/>			
	<b>LEGS</b>	Wood <input checked="" type="checkbox"/>	Metal <input type="checkbox"/>	Plastic <input type="checkbox"/>	Castors <input type="checkbox"/>	Upholstered <input type="checkbox"/>
	<b>FILLING</b>	Arms <input type="checkbox"/> Fiber <input checked="" type="checkbox"/> Foam <input type="checkbox"/> Feather/Fiber Mix <input type="checkbox"/> Feather	Seat cushion <input type="checkbox"/> Fiber <input checked="" type="checkbox"/> Foam <input type="checkbox"/> Feather/Fiber Mix <input type="checkbox"/> Feather	Back cushion <input type="checkbox"/> Fiber <input checked="" type="checkbox"/> Foam <input type="checkbox"/> Feather/Fiber Mix <input type="checkbox"/> Feather		
	<b>COMFORT</b>	Standard Comfort <input checked="" type="checkbox"/>	Firm Comfort <input type="checkbox"/>			
	<b>FUNCTION</b>	Bed <input type="checkbox"/>	Electric motion <input type="checkbox"/>	Motion <input type="checkbox"/>	Recliner <input type="checkbox"/>	Sliding <input type="checkbox"/>
	<b>OPTIONS</b>	Contrast Stitching <input type="checkbox"/>	Removable <input type="checkbox"/>	Nails <input type="checkbox"/>		

## NOTES

- LEATHER: Model is not available with articles Phoenix and Davinci.
- Stitching is always grey.
- Polyurethane which meets California/UK fire-resistance requirements.
- Expanded polyurethane seat and back.
- Tight Seat Cushion (the seat cushions of the models are fixed to the frame)
- Tight Back Cushion (the back cushions of the models are fixed to the frame)
- Structure in solid ashwood.
- Rag-applied finish, grey or smoked oak, with 5 gloss opaque transparent protective acrylic paint.
- With Feet Assembled (the model will be loaded with feet already mounted on the sofa)
- Legs with felt pads.
- Feet available in (01) Matte Grey or (02) Smoked Ashwood.
- Feet height 44,0 cm
- Chair always has grey coloured stitching.

NOTES

---





■ vers. 009



■ vers. 277 + 019



■ vers. 200 + 019



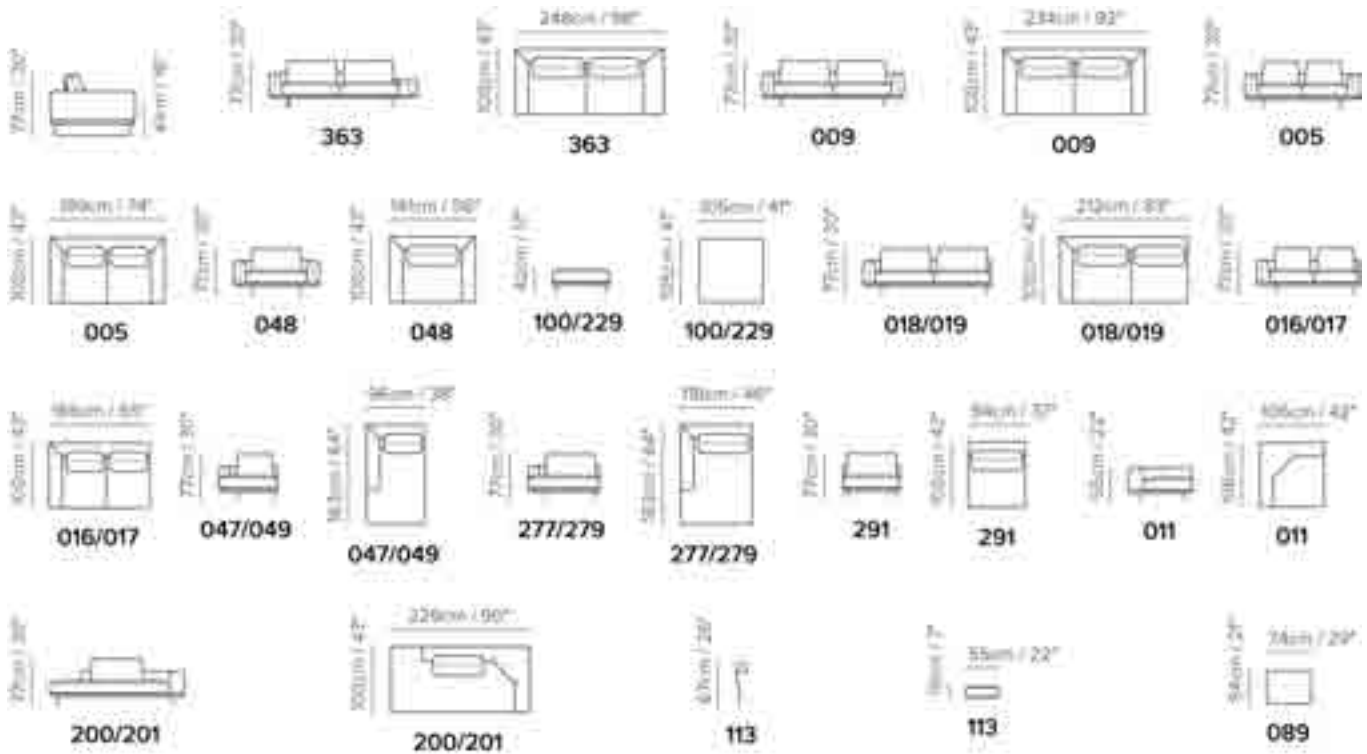



## SCHEMATICS



## COMPOSITION EXAMPLES



## TECHNICAL INFORMATION

	<b>COVERING</b>	Leather <input checked="" type="checkbox"/>	Soft Cover <input checked="" type="checkbox"/>			
	<b>LEGS</b>	Wood <input type="checkbox"/>	Metal <input checked="" type="checkbox"/>	Plastic <input type="checkbox"/>	Castors <input type="checkbox"/>	Upholstered <input type="checkbox"/>
	<b>FILLING</b>	Arms <input type="checkbox"/> Fiber <input checked="" type="checkbox"/> Foam <input type="checkbox"/> Feather/Fiber Mix <input type="checkbox"/> Feather	Seat cushion <input type="checkbox"/> Fiber <input checked="" type="checkbox"/> Foam <input type="checkbox"/> Feather/Fiber Mix <input checked="" type="checkbox"/> Feather	Back cushion <input type="checkbox"/> Fiber <input checked="" type="checkbox"/> Foam <input type="checkbox"/> Feather/Fiber Mix <input checked="" type="checkbox"/> Feather		
	<b>COMFORT</b>	Standard Comfort <input checked="" type="checkbox"/>	Firm Comfort <input type="checkbox"/>			
	<b>FUNCTION</b>	Bed <input type="checkbox"/>	Electric motion <input type="checkbox"/>	Motion <input type="checkbox"/>	Recliner <input type="checkbox"/>	Sliding <input type="checkbox"/>
	<b>OPTIONS</b>	Nails <input type="checkbox"/>	Removable <input type="checkbox"/>	Contrast Stitching <input checked="" type="checkbox"/>		

## NOTES

- For this model all leathers are available with contrast stitching. If you choose contrast, the stitching is always taupe. If you don't choose contrast, the stitching is tone-on-tone.
- Version 399 includes audio kit.
- Seat cushion includes a layer of memory foam, a pressure-sensitive soft polyurethane, that recovers its form completely thus giving great comfort
- Loose Seat Cushion (the seat cushions of the model are not fixed to the frame)
- With Leather Side (the sectional pieces come with leather sides)
- Wood Frame
- Without Feet Assembled (the feet will be in a bag inside the package)
- Plastic Wrap (the model will be wrapped in a plastic bag)
- Feet available in unique metal finishing powder coated dark grey
- Feet height 14,0 cm
- Arms of version 363 are different from eachother both for dimension and aesthetics

NOTES

---



■ vers. 003



■ vers. 003







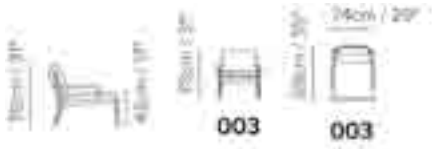

■ vers. 003

## SCHEMATICS

---



## TECHNICAL INFORMATION

	<b>COVERING</b>	Leather <input checked="" type="checkbox"/>	Soft Cover <input checked="" type="checkbox"/>			
	<b>LEGS</b>	Wood <input checked="" type="checkbox"/>	Metal <input type="checkbox"/>	Plastic <input type="checkbox"/>	Castors <input type="checkbox"/>	Upholstered <input type="checkbox"/>
	<b>FILLING</b>	Arms <input type="checkbox"/> Fiber <input checked="" type="checkbox"/> Foam <input type="checkbox"/> Feather/Fiber Mix <input type="checkbox"/> Feather	Seat cushion <input type="checkbox"/> Fiber <input checked="" type="checkbox"/> Foam <input type="checkbox"/> Feather/Fiber Mix <input checked="" type="checkbox"/> Feather	Back cushion <input type="checkbox"/> Fiber <input checked="" type="checkbox"/> Foam <input type="checkbox"/> Feather/Fiber Mix <input checked="" type="checkbox"/> Feather		
	<b>COMFORT</b>	Standard Comfort <input checked="" type="checkbox"/>	Firm Comfort <input checked="" type="checkbox"/>			
	<b>FUNCTION</b>	Bed <input type="checkbox"/>	Electric motion <input type="checkbox"/>	Motion <input type="checkbox"/>	Recliner <input type="checkbox"/>	Sliding <input type="checkbox"/>
	<b>OPTIONS</b>	Contrast Stitching <input type="checkbox"/>	Removable <input type="checkbox"/>	Nails <input type="checkbox"/>		

## NOTES

- Tight Seat Cushion (the seat cushions of the models are fixed to the frame)
- Wood Frame
- With Feet Assembled (the model will be loaded with feet already mounted on the sofa)
- Front feet are slightly higher in respect to rear.
- Feet available in wood finishing 18 (Wengè)
- Feet height 26,0/19,0 cm
- Arms are available in metal with finishing lacquered coffee

NOTES

---





■ vers. 009



■ vers. 005



■ vers. 018 + 481







## SCHEMATICS



## COMPOSITION EXAMPLES



## TECHNICAL INFORMATION

	<b>COVERING</b>	Leather <input checked="" type="checkbox"/>	Soft Cover <input checked="" type="checkbox"/>			
	<b>LEGS</b>	Wood <input type="checkbox"/>	Metal <input checked="" type="checkbox"/>	Plastic <input type="checkbox"/>	Castors <input type="checkbox"/>	Upholstered <input type="checkbox"/>
	<b>FILLING</b>	Arms <input type="checkbox"/> Fiber <input checked="" type="checkbox"/> Foam <input type="checkbox"/> Feather/Fiber Mix <input type="checkbox"/> Feather	Seat cushion <input type="checkbox"/> Fiber <input checked="" type="checkbox"/> Foam <input type="checkbox"/> Feather/Fiber Mix <input type="checkbox"/> Feather	Back cushion <input type="checkbox"/> Fiber <input checked="" type="checkbox"/> Foam <input type="checkbox"/> Feather/Fiber Mix <input type="checkbox"/> Feather		
	<b>COMFORT</b>	Standard Comfort <input checked="" type="checkbox"/>	Firm Comfort <input type="checkbox"/>			
	<b>FUNCTION</b>	Bed <input type="checkbox"/>	Electric motion <input type="checkbox"/>	Motion <input type="checkbox"/>	Recliner <input type="checkbox"/>	Sliding <input type="checkbox"/>
	<b>OPTIONS</b>	Nails <input type="checkbox"/>	Removable <input type="checkbox"/>	Contrast Stitching <input checked="" type="checkbox"/>		

## NOTES

- Versions 480/481 have terminal seats with adjustable backrests.
- Contrast stitching is available only with certain covers and option is managed directly in NARES.
- Tight Seat Cushion (the seat cushions of the models are fixed to the frame)
- Tight Back Cushion (the back cushions of the models are fixed to the frame)
- No Leather Side (the sectional pieces have the side covered with fabric and not leather)
- Wood Frame
- Without Feet Assembled (the feet will be in a bag inside the package)
- Plastic Wrap (the model will be wrapped in a plastic bag)
- Feet available in metal finishing 77 (Glossy Chromed)
- Feet height 15,0 cm

NOTES

---



■ vers. 018 + 011 + 073



■ vers. 018 + 011 + 073



■ vers. 018 + 049



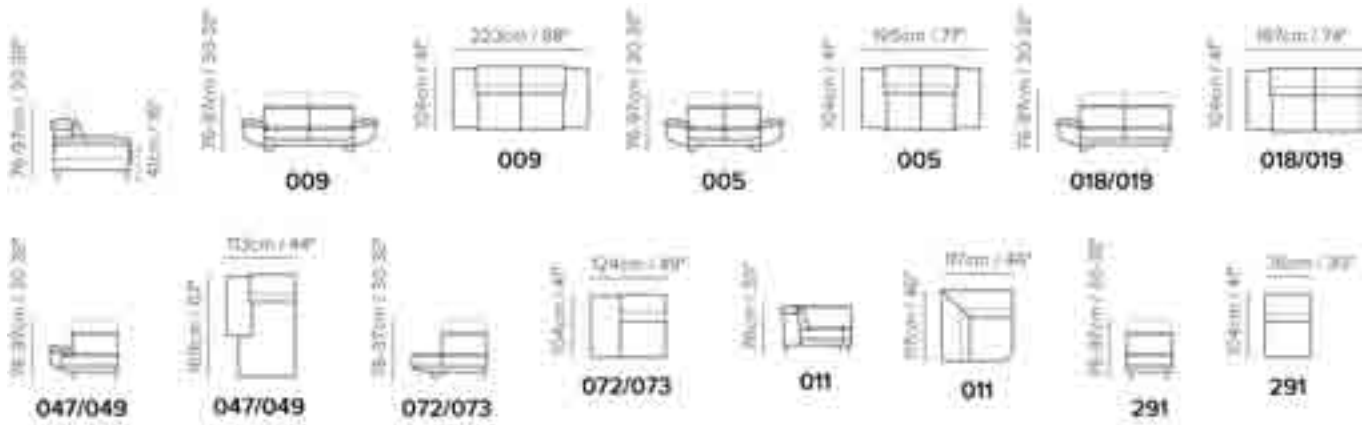



## SCHEMATICS



## COMPOSITION EXAMPLES



## TECHNICAL INFORMATION

	<b>COVERING</b>	Leather <input checked="" type="checkbox"/>	Soft Cover <input checked="" type="checkbox"/>			
	<b>LEGS</b>	Wood <input type="checkbox"/>	Metal <input checked="" type="checkbox"/>	Plastic <input type="checkbox"/>	Castors <input type="checkbox"/>	Upholstered <input type="checkbox"/>
	<b>FILLING</b>	Arms <input type="checkbox"/> Fiber <input checked="" type="checkbox"/> Foam <input type="checkbox"/> Feather/Fiber Mix <input type="checkbox"/> Feather	Seat cushion <input type="checkbox"/> Fiber <input checked="" type="checkbox"/> Foam <input type="checkbox"/> Feather/Fiber Mix <input type="checkbox"/> Feather	Back cushion <input type="checkbox"/> Fiber <input checked="" type="checkbox"/> Foam <input type="checkbox"/> Feather/Fiber Mix <input type="checkbox"/> Feather		
	<b>COMFORT</b>	Standard Comfort <input checked="" type="checkbox"/>	Firm Comfort <input checked="" type="checkbox"/>			
	<b>FUNCTION</b>	Bed <input type="checkbox"/>	Electric motion <input type="checkbox"/>	Motion <input type="checkbox"/>	Recliner <input type="checkbox"/>	Sliding <input type="checkbox"/>
	<b>OPTIONS</b>	Contrast Stitching <input type="checkbox"/>	Removable <input type="checkbox"/>	Nails <input type="checkbox"/>		

## NOTES

- Tight Seat Cushion (the seat cushions of the models are fixed to the frame)
- Tight Back Cushion (the back cushions of the models are fixed to the frame)
- With Leather Side (the sectional pieces come with leather sides)
- Wood Frame
- Without Feet Assembled (the feet will be in a bag inside the package)
- Plastic Wrap (the model will be wrapped in a plastic bag)
- Feet available in metal finishing 77 (Glossy Chromed)
- Feet height 12,0 cm

NOTES

---





■ vers. 001 + 033 + 038 + 057



■ vers. 001 + 033 + 038 + 057



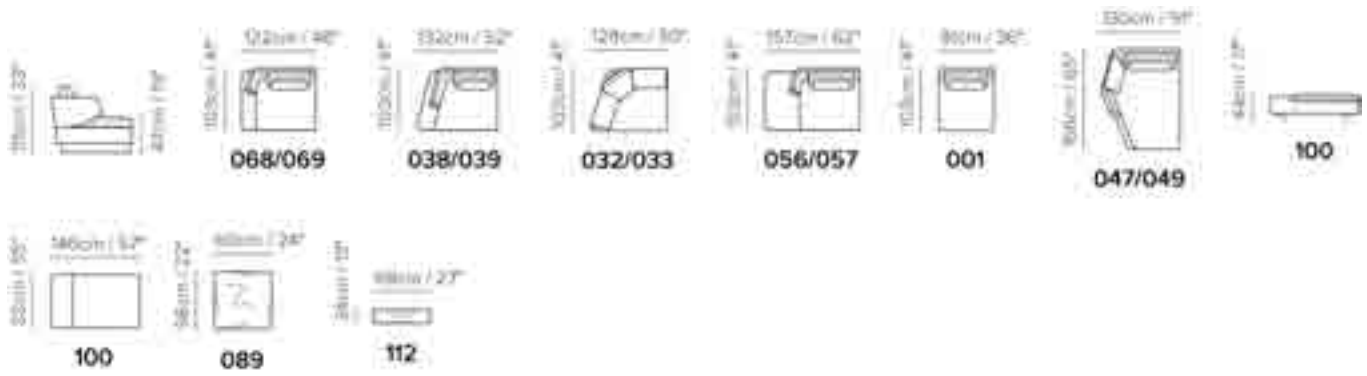

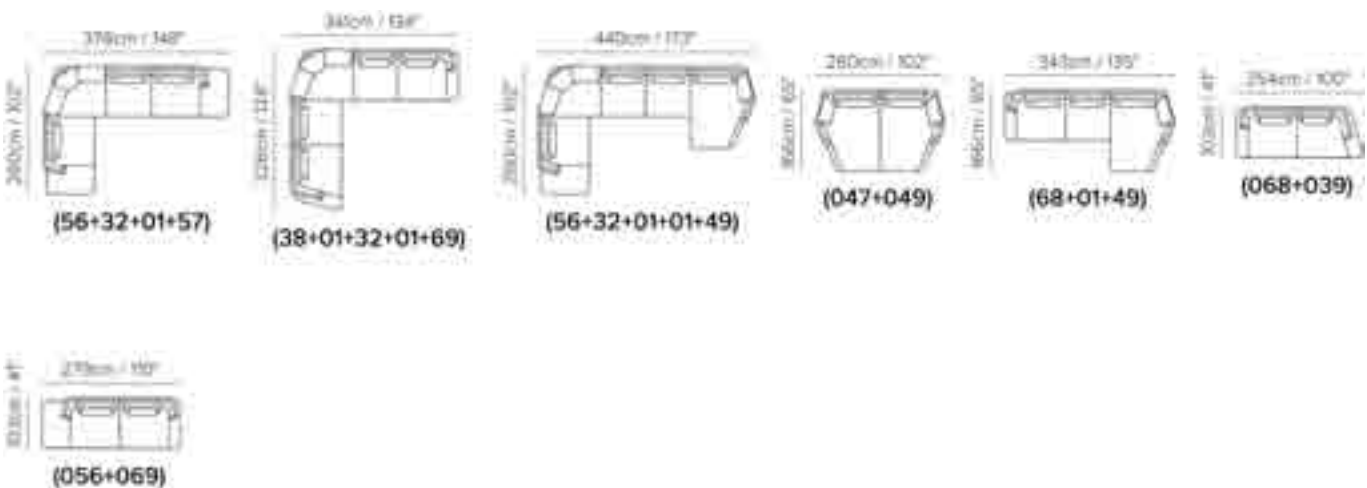

## SCHEMATICS



## COMPOSITION EXAMPLES



## TECHNICAL INFORMATION

	<b>COVERING</b>	Mix <input checked="" type="checkbox"/>	Leather <input checked="" type="checkbox"/>	Soft Cover <input checked="" type="checkbox"/>		
	<b>LEGS</b>	Wood <input type="checkbox"/>	Metal <input checked="" type="checkbox"/>	Plastic <input type="checkbox"/>	Castors <input type="checkbox"/>	Upholstered <input type="checkbox"/>
	<b>FILLING</b>	Arms <input type="checkbox"/> Fiber <input checked="" type="checkbox"/> Foam <input type="checkbox"/> Feather/Fiber Mix <input type="checkbox"/> Feather	Seat cushion <input type="checkbox"/> Fiber <input checked="" type="checkbox"/> Foam <input type="checkbox"/> Feather/Fiber Mix <input checked="" type="checkbox"/> Feather	Back cushion <input type="checkbox"/> Fiber <input checked="" type="checkbox"/> Foam <input type="checkbox"/> Feather/Fiber Mix <input checked="" type="checkbox"/> Feather		
	<b>COMFORT</b>	Standard Comfort <input checked="" type="checkbox"/>	Firm Comfort <input type="checkbox"/>			
	<b>FUNCTION</b>	Bed <input type="checkbox"/>	Electric motion <input type="checkbox"/>	Motion <input type="checkbox"/>	Recliner <input type="checkbox"/>	Sliding <input type="checkbox"/>
	<b>OPTIONS</b>	Nails <input type="checkbox"/>	Removable <input type="checkbox"/>	Contrast Stitching <input type="checkbox"/>		

## NOTES

- Seat cushion includes a layer of memory foam, a pressure-sensitive soft polyurethane, that recovers its form completely thus giving great comfort
- Seat cushion zippered (the seat cushion is attached to the frame through a zipper)
- Back Cushion Zippered (the back cushion is attached to the frame through a zipper)
- Wood Frame
- Without Feet Assembled (the feet will be in a bag inside the package)
- Plastic Wrap (the model will be wrapped in a plastic bag)
- Feet available in metal finishings 75 (Glazed Nickel) / 77 (Glossy Chromed)
- Feet height 12,0 cm
- Versions 001/056/057/068/069 include 1 kidney pillow.
- Versions 032/033 include 2 small cushions and 1 large cushion.
- Versions 038/039 include 1 small cushion.
- Versions 047/049 include 1 small cushion and 1 kidney pillow.
- LEATHER-FABRIC MIX COVERING OPTIONS:
- 1° COV. (Leather) = Frame
- 2° COV. (Fabric) = Seat and back cushions
- 3° COV. (Fabric) = Small cushion / kidney pillow
- THREE TONE COVERING OPTION IN FABRIC:
- 1° COV. = Frame
- 2° COV. = Seat and back cushions

### NOTES

---

- 3° COV. = Small cushion / kidney pillows



■ Vers. 003



■ Vers. 003







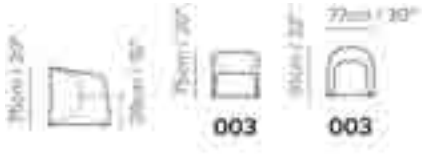

■ Vers. 003

## SCHEMATICS

---



## TECHNICAL INFORMATION

	<b>COVERING</b>	Mix <input checked="" type="checkbox"/>	Leather <input checked="" type="checkbox"/>			
	<b>LEGS</b>	Wood <input type="checkbox"/>	Metal <input type="checkbox"/>	Plastic <input type="checkbox"/>	Castors <input type="checkbox"/>	Upholstered <input type="checkbox"/>
	<b>FILLING</b>	Arms <input type="checkbox"/> Fiber <input checked="" type="checkbox"/> Foam <input type="checkbox"/> Feather/Fiber Mix <input type="checkbox"/> Feather	Seat cushion <input type="checkbox"/> Fiber <input checked="" type="checkbox"/> Foam <input type="checkbox"/> Feather/Fiber Mix <input type="checkbox"/> Feather	Back cushion <input type="checkbox"/> Fiber <input checked="" type="checkbox"/> Foam <input type="checkbox"/> Feather/Fiber Mix <input type="checkbox"/> Feather		
	<b>COMFORT</b>	Standard Comfort <input checked="" type="checkbox"/>	Firm Comfort <input type="checkbox"/>			
	<b>FUNCTION</b>	Bed <input type="checkbox"/>	Electric motion <input type="checkbox"/>	Motion <input type="checkbox"/>	Recliner <input type="checkbox"/>	Sliding <input type="checkbox"/>
	<b>OPTIONS</b>	Contrast Stitching <input type="checkbox"/>	Removable <input type="checkbox"/>	Nails <input type="checkbox"/>		

## NOTES

- Seat cushion includes a layer of memory foam, a pressure-sensitive soft polyurethane, that recovers its form completely thus giving great comfort
- Tight Seat Cushion (the seat cushions of the models are fixed to the frame)
- Tight Back Cushion (the back cushions of the models are fixed to the frame)
- Wood Frame
- Without Feet Assembled (the feet will be in a bag inside the package)
- Plastic Wrap (the model will be wrapped in a plastic bag)
- Feet height 4,5 cm
- LEATHER-FABRIC MIX COVERING OPTIONS:
- 1° COV. (Leather) = Frame
- 2° COV. (Fabric) = Seat and back cushions

NOTES

---











■ vers. 003

## SCHEMATICS

---



## TECHNICAL INFORMATION

	<b>COVERING</b>	Leather <input checked="" type="checkbox"/>	Soft Cover <input checked="" type="checkbox"/>			
	<b>LEGS</b>	Wood <input type="checkbox"/>	Metal <input type="checkbox"/>	Plastic <input type="checkbox"/>	Castors <input type="checkbox"/>	Upholstered <input checked="" type="checkbox"/>
	<b>FILLING</b>	Arms <input type="checkbox"/> Fiber <input checked="" type="checkbox"/> Foam <input type="checkbox"/> Feather/Fiber Mix <input type="checkbox"/> Feather	Seat cushion <input type="checkbox"/> Fiber <input checked="" type="checkbox"/> Foam <input type="checkbox"/> Feather/Fiber Mix <input type="checkbox"/> Feather	Back cushion <input type="checkbox"/> Fiber <input checked="" type="checkbox"/> Foam <input type="checkbox"/> Feather/Fiber Mix <input type="checkbox"/> Feather		
	<b>COMFORT</b>	Standard Comfort <input checked="" type="checkbox"/>	Firm Comfort <input type="checkbox"/>			
	<b>FUNCTION</b>	Bed <input type="checkbox"/>	Electric motion <input type="checkbox"/>	Motion <input type="checkbox"/>	Recliner <input type="checkbox"/>	Sliding <input type="checkbox"/>
	<b>OPTIONS</b>	Nails <input type="checkbox"/>	Removable <input type="checkbox"/>	Contrast Stitching <input type="checkbox"/>		

## NOTES

- LEATHER: Model is not available with articles Phoenix, Armstrong, Montello, Davinci and Nubuk.
- Tight Seat Cushion (the seat cushions of the models are fixed to the frame)
- Tight Back Cushion (the back cushions of the models are fixed to the frame)
- With Feet Assembled (the model will be loaded with feet already mounted on the sofa)
- Plastic Wrap (the model will be wrapped in a plastic bag)

NOTES

---







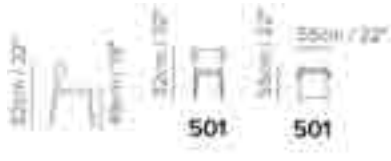

■ vers. 003

## SCHEMATICS

---



## TECHNICAL INFORMATION

	<b>COVERING</b>	Leather <input checked="" type="checkbox"/>	Soft Cover <input checked="" type="checkbox"/>			
	<b>LEGS</b>	Wood <input type="checkbox"/>	Metal <input type="checkbox"/>	Plastic <input type="checkbox"/>	Castors <input type="checkbox"/>	Upholstered <input checked="" type="checkbox"/>
	<b>FILLING</b>	Arms <input type="checkbox"/> Fiber <input checked="" type="checkbox"/> Foam <input type="checkbox"/> Feather/Fiber Mix <input type="checkbox"/> Feather	Seat cushion <input type="checkbox"/> Fiber <input checked="" type="checkbox"/> Foam <input type="checkbox"/> Feather/Fiber Mix <input type="checkbox"/> Feather	Back cushion <input type="checkbox"/> Fiber <input checked="" type="checkbox"/> Foam <input type="checkbox"/> Feather/Fiber Mix <input type="checkbox"/> Feather		
	<b>COMFORT</b>	Standard Comfort <input checked="" type="checkbox"/>	Firm Comfort <input type="checkbox"/>			
	<b>FUNCTION</b>	Bed <input type="checkbox"/>	Electric motion <input type="checkbox"/>	Motion <input type="checkbox"/>	Recliner <input type="checkbox"/>	Sliding <input type="checkbox"/>
	<b>OPTIONS</b>	Contrast Stitching <input type="checkbox"/>	Removable <input type="checkbox"/>	Nails <input type="checkbox"/>		

## NOTES

- LEATHER: Model is not available with articles Phoenix, Armstrong, Montello, Davinci and Nubuk.
- Tight Seat Cushion (the seat cushions of the models are fixed to the frame)
- Tight Back Cushion (the back cushions of the models are fixed to the frame)
- With Feet Assembled (the model will be loaded with feet already mounted on the sofa)
- Plastic Wrap (the model will be wrapped in a plastic bag)

NOTES

---





■ Vers. 529



■ Vers. 529







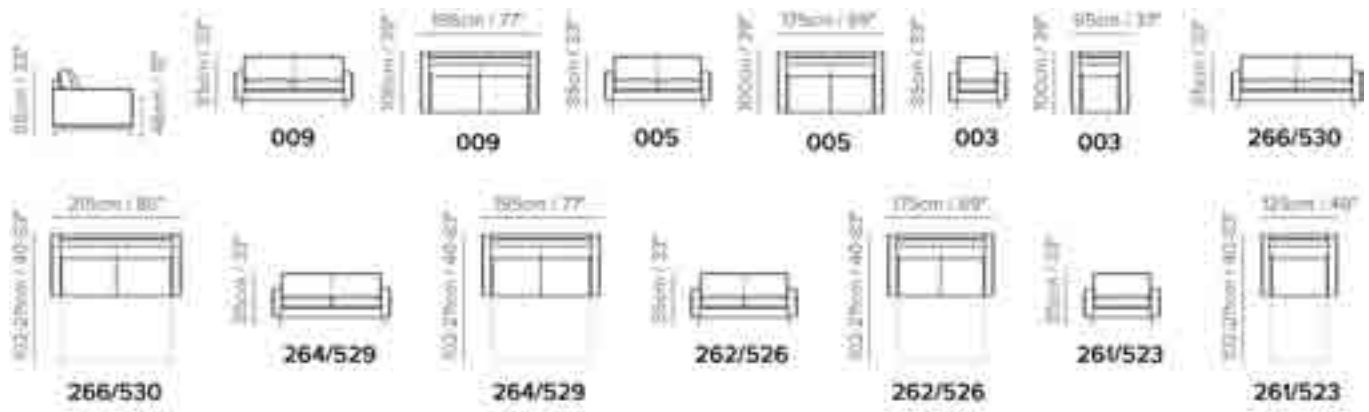

■ Vers. 529

## SCHEMATICS



## TECHNICAL INFORMATION

	<b>COVERING</b>	Soft Cover <input checked="" type="checkbox"/>					
	<b>LEGS</b>	Wood <input type="checkbox"/>	Metal <input checked="" type="checkbox"/>	Plastic <input type="checkbox"/>	Castors <input type="checkbox"/>	Upholstered <input type="checkbox"/>	
	<b>FILLING</b>	Arms	<input type="checkbox"/> Fiber <input checked="" type="checkbox"/> Foam <input type="checkbox"/> Feather/Fiber Mix <input type="checkbox"/> Feather	Seat cushion	<input type="checkbox"/> Fiber <input checked="" type="checkbox"/> Foam <input type="checkbox"/> Feather/Fiber Mix <input type="checkbox"/> Feather	Back cushion	<input type="checkbox"/> Fiber <input checked="" type="checkbox"/> Foam <input type="checkbox"/> Feather/Fiber Mix <input type="checkbox"/> Feather
	<b>COMFORT</b>	Standard Comfort <input checked="" type="checkbox"/>		Firm Comfort <input type="checkbox"/>			
	<b>FUNCTION</b>	Bed <input checked="" type="checkbox"/>	Electric motion <input type="checkbox"/>	Motion <input type="checkbox"/>	Recliner <input type="checkbox"/>	Sliding <input type="checkbox"/>	
	<b>OPTIONS</b>	Nails <input type="checkbox"/>	Removable <input type="checkbox"/>	Contrast Stitching <input type="checkbox"/>			

## BED MECHANISM & MATTRESS

MECHANISM		MATTRESS		
VERSIONS	TYPE	VERSIONS	TYPE	DIMENSIONS
				W L H
262,526	Ready-Bed electro-welded - Double folding	523	Memory	70 185 11
264,529	Ready-Bed electro-welded - Double folding	261	GREENPLUS	70 195 11
266,530	Ready-Bed electro-welded - Double folding	262	GREENPLUS	120 195 11
		526	Memory	120 195 11
		264	GREENPLUS	140 195 11
		529	Memory	140 195 11
		266	GREENPLUS	160 195 11
		530	Memory	160 195 11

### Ready-Bed electro-welded

The back cushion goes under the bed mechanism which contains a set of pillow holder.

### Memory

Non-allergic memory mattress available with zippered cover that can be easily taken off and washed.

### GREENPLUS

GREENPLUS mattress is a patented, innovative product. It is ecological, made up of microporous elastomers. It has a great adaptation capacity to the various body pressure which gives big support to the spine. It is antibacterial and no-allergic.

## NOTES

- Model is available with contrast welt to be entered as second covering
- Tight Seat Cushion (the seat cushions of the models are fixed to the frame)
- Tight Back Cushion (the back cushions of the models are fixed to the frame)
- Wood Frame
- Without Feet Assembled (the feet will be in a bag inside the package)
- Plastic Wrap (the model will be wrapped in a plastic bag)
- Feet available in metal finishings 77 (Glossy Chromed) / 78 (Glossy Black)
- Feet height 13,0 cm

NOTES

---



■ Vers. 009+089+089+112+112



■ Vers. 009+089+089+112+112







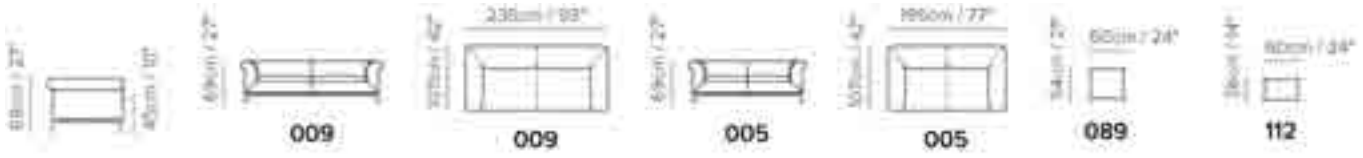

■ Vers. 005+089+089+112+112

## SCHEMATICS

---



## TECHNICAL INFORMATION

	<b>COVERING</b>	Leather <input checked="" type="checkbox"/>	Soft Cover <input checked="" type="checkbox"/>			
	<b>LEGS</b>	Wood <input checked="" type="checkbox"/>	Metal <input type="checkbox"/>	Plastic <input type="checkbox"/>	Castors <input type="checkbox"/>	Upholstered <input type="checkbox"/>
	<b>FILLING</b>	Arms <input type="checkbox"/> Fiber <input checked="" type="checkbox"/> Foam <input type="checkbox"/> Feather/Fiber Mix <input type="checkbox"/> Feather	Seat cushion <input type="checkbox"/> Fiber <input checked="" type="checkbox"/> Foam <input checked="" type="checkbox"/> Feather/Fiber Mix <input type="checkbox"/> Feather	Back cushion <input type="checkbox"/> Fiber <input checked="" type="checkbox"/> Foam <input type="checkbox"/> Feather/Fiber Mix <input type="checkbox"/> Feather		
	<b>COMFORT</b>	Standard Comfort <input checked="" type="checkbox"/>	Firm Comfort <input type="checkbox"/>			
	<b>FUNCTION</b>	Bed <input type="checkbox"/>	Electric motion <input type="checkbox"/>	Motion <input type="checkbox"/>	Recliner <input type="checkbox"/>	Sliding <input type="checkbox"/>
	<b>OPTIONS</b>	Contrast Stitching <input type="checkbox"/>	Removable <input type="checkbox"/>	Nails <input type="checkbox"/>		

## NOTES

- Model is available with contrast welt to be entered as second covering
- Seat cushion includes a layer of memory foam, a pressure-sensitive soft polyurethane, that recovers its form completely thus giving great comfort
- Tight Seat Cushion (the seat cushions of the models are fixed to the frame)
- Tight Back Cushion (the back cushions of the models are fixed to the frame)
- Wood Frame
- With Feet Assembled (the model will be loaded with feet already mounted on the sofa)
- Plastic Wrap (the model will be wrapped in a plastic bag)
- Feet available in wood finishings 29 (Coffee) with metal insert 78 (Glossy Black)
- Feet height 17,0 cm

NOTES

---





■ Vers. 008



■ Vers. 008







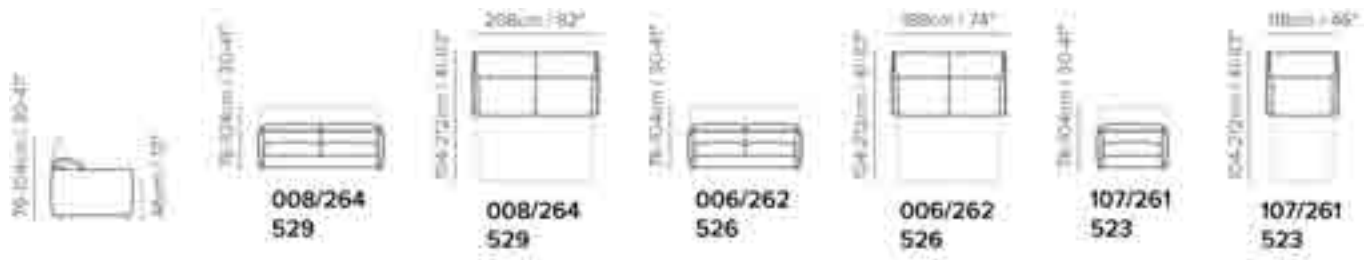

■ Vers. 008

## SCHEMATICS



## TECHNICAL INFORMATION

	<b>COVERING</b>	Soft Cover <input checked="" type="checkbox"/>					
	<b>LEGS</b>	Wood <input type="checkbox"/>	Metal <input type="checkbox"/>	Plastic <input checked="" type="checkbox"/>	Castors <input type="checkbox"/>	Upholstered <input type="checkbox"/>	
	<b>FILLING</b>	Arms	<input type="checkbox"/> Fiber <input checked="" type="checkbox"/> Foam <input type="checkbox"/> Feather/Fiber Mix <input type="checkbox"/> Feather	Seat cushion	<input type="checkbox"/> Fiber <input checked="" type="checkbox"/> Foam <input type="checkbox"/> Feather/Fiber Mix <input type="checkbox"/> Feather	Back cushion	<input type="checkbox"/> Fiber <input checked="" type="checkbox"/> Foam <input type="checkbox"/> Feather/Fiber Mix <input type="checkbox"/> Feather
	<b>COMFORT</b>	Standard Comfort <input checked="" type="checkbox"/>		Firm Comfort <input type="checkbox"/>			
	<b>FUNCTION</b>	Bed <input checked="" type="checkbox"/>	Electric motion <input type="checkbox"/>	Motion <input type="checkbox"/>	Recliner <input type="checkbox"/>	Sliding <input type="checkbox"/>	
	<b>OPTIONS</b>	Nails <input type="checkbox"/>	Removable <input type="checkbox"/>	Contrast Stitching <input type="checkbox"/>			

## BED MECHANISM & MATTRESS

MECHANISM		MATTRESS		
VERSIONS	TYPE	VERSIONS	TYPE	DIMENSIONS
				W L H
107,261,523	Ready-Bed electro-welded - Double folding	523	Memory	70 185 11
006,262,526	Ready-Bed electro-welded - Double folding	107	Spring	70 191 13,5
008,264,529	Ready-Bed electro-welded - Double folding	261	GREENPLUS	70 195 11
		006	Spring	140 190 14
		262	GREENPLUS	140 195 11
		526	Memory	140 195 11
		008	Spring	160 190 14
		264	GREENPLUS	160 195 11
		529	Memory	160 195 11

### Ready-Bed electro-welded

The back cushion goes under the bed mechanism which contains a set of pillow holder.

### Memory

Non-allergic memory mattress available with zippered cover that can be easily taken off and washed.

### GREENPLUS

GREENPLUS mattress is a patented, innovative product. It is ecological, made up of microporous elastomers. It has a great adaptation capacity to the various body pressure which gives big support to the spine. It is antibacterial and no-allergic.

## NOTES

- Seat cushion includes a layer of memory foam, a pressure-sensitive soft polyurethane, that recovers its form completely thus giving great comfort
- Tight Seat Cushion (the seat cushions of the models are fixed to the frame)
- Tight Back Cushion (the back cushions of the models are fixed to the frame)
- Wood Frame
- With Feet Assembled (the model will be loaded with feet already mounted on the sofa)
- Plastic Wrap (the model will be wrapped in a plastic bag)
- Feet height 3,0 cm
- TWO TONE COVERING OPTIONS:
- 1° COV. = Sofa

### NOTES

---

- 2° COV. = Welt and kidney pillows



■ Vers. 003



■ Vers. 003







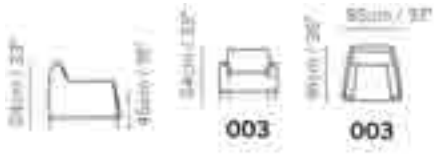

■ Vers. 003

## SCHEMATICS

---



## TECHNICAL INFORMATION

	<b>COVERING</b>	Leather <input checked="" type="checkbox"/>	Soft Cover <input checked="" type="checkbox"/>			
	<b>LEGS</b>	Wood <input type="checkbox"/>	Metal <input checked="" type="checkbox"/>	Plastic <input type="checkbox"/>	Castors <input type="checkbox"/>	Upholstered <input type="checkbox"/>
	<b>FILLING</b>	Arms <input type="checkbox"/> Fiber <input checked="" type="checkbox"/> Foam <input type="checkbox"/> Feather/Fiber Mix <input type="checkbox"/> Feather	Seat cushion <input type="checkbox"/> Fiber <input checked="" type="checkbox"/> Foam <input type="checkbox"/> Feather/Fiber Mix <input type="checkbox"/> Feather	Back cushion <input type="checkbox"/> Fiber <input checked="" type="checkbox"/> Foam <input type="checkbox"/> Feather/Fiber Mix <input type="checkbox"/> Feather		
	<b>COMFORT</b>	Standard Comfort <input checked="" type="checkbox"/>	Firm Comfort <input type="checkbox"/>			
	<b>FUNCTION</b>	Bed <input type="checkbox"/>	Electric motion <input type="checkbox"/>	Motion <input type="checkbox"/>	Recliner <input type="checkbox"/>	Sliding <input type="checkbox"/>
	<b>OPTIONS</b>	Contrast Stitching <input type="checkbox"/>	Removable <input type="checkbox"/>	Nails <input type="checkbox"/>		

## NOTES

- Model is available with contrast welt to be entered as second covering
- Seat cushion includes a layer of memory foam, a pressure-sensitive soft polyurethane, that recovers its form completely thus giving great comfort
- Tight Seat Cushion (the seat cushions of the models are fixed to the frame)
- Tight Back Cushion (the back cushions of the models are fixed to the frame)
- Wood Frame
- Without Feet Assembled (the feet will be in a bag inside the package)
- Plastic Wrap (the model will be wrapped in a plastic bag)
- Feet available in metal finishings 77 (Glossy Chromed) / 78 (Glossy Black)
- Feet height 13,0 cm

NOTES

---





■ Vers. 009+126+126+089



■ Vers. 009+126+126+089



■ Vers. 200+019+126+126+089+089+112+112



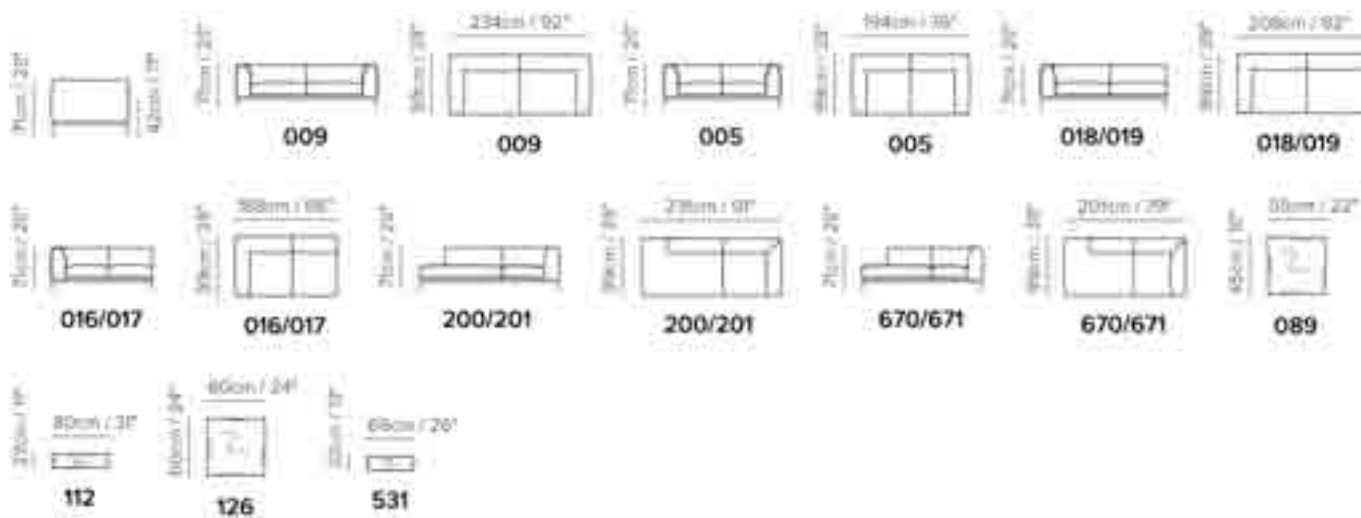



## SCHEMATICS



## COMPOSITION EXAMPLES



## TECHNICAL INFORMATION

	<b>COVERING</b>	Leather <input checked="" type="checkbox"/>	Soft Cover <input checked="" type="checkbox"/>			
	<b>LEGS</b>	Wood <input checked="" type="checkbox"/>	Metal <input type="checkbox"/>	Plastic <input type="checkbox"/>	Castors <input type="checkbox"/>	Upholstered <input type="checkbox"/>
	<b>FILLING</b>	Arms <input type="checkbox"/> Fiber <input checked="" type="checkbox"/> Foam <input type="checkbox"/> Feather/Fiber Mix <input type="checkbox"/> Feather	Seat cushion <input type="checkbox"/> Fiber <input checked="" type="checkbox"/> Foam <input type="checkbox"/> Feather/Fiber Mix <input type="checkbox"/> Feather	Back cushion <input type="checkbox"/> Fiber <input checked="" type="checkbox"/> Foam <input type="checkbox"/> Feather/Fiber Mix <input type="checkbox"/> Feather		
	<b>COMFORT</b>	Standard Comfort <input checked="" type="checkbox"/>	Firm Comfort <input type="checkbox"/>			
	<b>FUNCTION</b>	Bed <input type="checkbox"/>	Electric motion <input type="checkbox"/>	Motion <input type="checkbox"/>	Recliner <input type="checkbox"/>	Sliding <input type="checkbox"/>
	<b>OPTIONS</b>	Nails <input type="checkbox"/>	Removable <input type="checkbox"/>	Contrast Stitching <input type="checkbox"/>		

## NOTES

- Seat cushion includes a layer of memory foam, a pressure-sensitive soft polyurethane, that recovers its form completely thus giving great comfort
- Loose Seat Cushion (the seat cushions of the model are not fixed to the frame)
- Tight Back Cushion (the back cushions of the models are fixed to the frame)
- With Leather Side (the sectional pieces come with leather sides)
- Wood Frame
- With Feet Assembled (the model will be loaded with feet already mounted on the sofa)
- Plastic Wrap (the model will be wrapped in a plastic bag)
- Feet available in wood finishings 29 (Coffee) with metal insert 78 (Glossy Black)

NOTES

---



■ Vers. 272+274



■ Vers. 272+274



■ Vers. 100



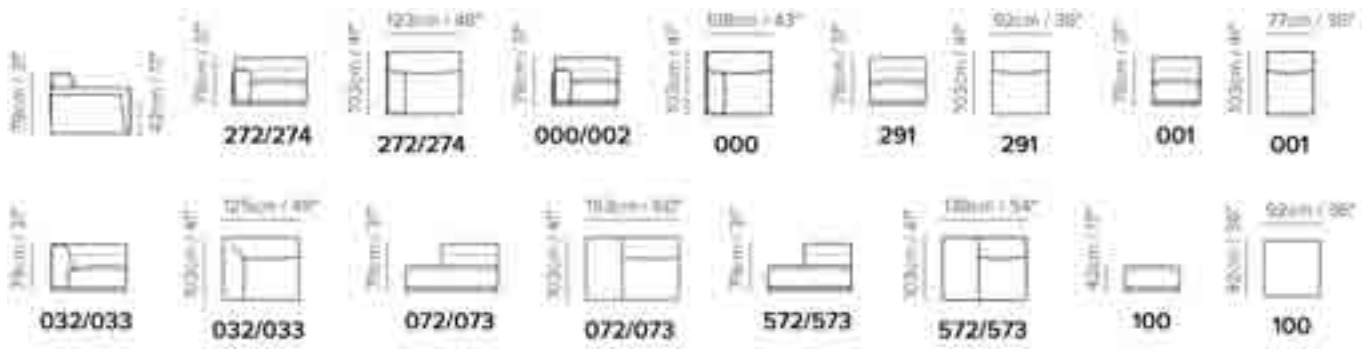



## SCHEMATICS



## COMPOSITION EXAMPLES



## TECHNICAL INFORMATION

	<b>COVERING</b>	Leather <input checked="" type="checkbox"/>	Soft Cover <input checked="" type="checkbox"/>			
	<b>LEGS</b>	Wood <input type="checkbox"/>	Metal <input type="checkbox"/>	Plastic <input type="checkbox"/>	Castors <input type="checkbox"/>	Upholstered <input type="checkbox"/>
	<b>FILLING</b>	Arms <input type="checkbox"/> Fiber <input checked="" type="checkbox"/> Foam <input type="checkbox"/> Feather/Fiber Mix <input checked="" type="checkbox"/> Feather	Seat cushion <input type="checkbox"/> Fiber <input checked="" type="checkbox"/> Foam <input type="checkbox"/> Feather/Fiber Mix <input checked="" type="checkbox"/> Feather	Back cushion <input type="checkbox"/> Fiber <input checked="" type="checkbox"/> Foam <input type="checkbox"/> Feather/Fiber Mix <input checked="" type="checkbox"/> Feather		
	<b>COMFORT</b>	Standard Comfort <input checked="" type="checkbox"/>	Firm Comfort <input type="checkbox"/>			
	<b>FUNCTION</b>	Bed <input type="checkbox"/>	Electric motion <input type="checkbox"/>	Motion <input type="checkbox"/>	Recliner <input type="checkbox"/>	Sliding <input type="checkbox"/>
	<b>OPTIONS</b>	Contrast Stitching <input type="checkbox"/>	Removable <input type="checkbox"/>	Nails <input type="checkbox"/>		

## NOTES

- Model also available with thick leather with model code Sxxx (Art. Vesuvio, Cassidy).
- Seat cushion includes a layer of memory foam, a pressure-sensitive soft polyurethane, that recovers its form completely thus giving great comfort
- Tight Seat Cushion (the seat cushions of the models are fixed to the frame)
- Tight Back Cushion (the back cushions of the models are fixed to the frame)
- With Leather Side (the sectional pieces come with leather sides)
- Wood Frame
- With Feet Assembled (the model will be loaded with feet already mounted on the sofa)
- Plastic Wrap (the model will be wrapped in a plastic bag)
- Feet height 3,0 cm

NOTES

---





■ Vers. 009



■ Vers. 009







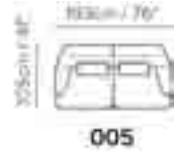
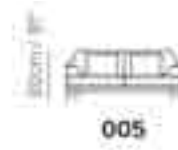
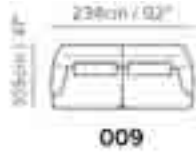
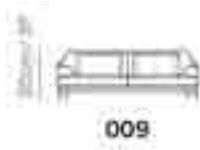

■ Vers. 005

## SCHEMATICS

---



## TECHNICAL INFORMATION

	<b>COVERING</b>	Leather <input checked="" type="checkbox"/>	Soft Cover <input checked="" type="checkbox"/>			
	<b>LEGS</b>	Wood <input type="checkbox"/>	Metal <input checked="" type="checkbox"/>	Plastic <input type="checkbox"/>	Castors <input type="checkbox"/>	Upholstered <input type="checkbox"/>
	<b>FILLING</b>	Arms <input type="checkbox"/> Fiber <input checked="" type="checkbox"/> Foam <input type="checkbox"/> Feather/Fiber Mix <input type="checkbox"/> Feather	Seat cushion <input type="checkbox"/> Fiber <input checked="" type="checkbox"/> Foam <input type="checkbox"/> Feather/Fiber Mix <input type="checkbox"/> Feather	Back cushion <input type="checkbox"/> Fiber <input checked="" type="checkbox"/> Foam <input type="checkbox"/> Feather/Fiber Mix <input type="checkbox"/> Feather		
	<b>COMFORT</b>	Standard Comfort <input checked="" type="checkbox"/>	Firm Comfort <input type="checkbox"/>			
	<b>FUNCTION</b>	Bed <input type="checkbox"/>	Electric motion <input type="checkbox"/>	Motion <input type="checkbox"/>	Recliner <input type="checkbox"/>	Sliding <input type="checkbox"/>
	<b>OPTIONS</b>	Nails <input type="checkbox"/>	Removable <input type="checkbox"/>	Contrast Stitching <input type="checkbox"/>		

## NOTES

- Model is available with contrast welt to be entered as second covering
- Seat cushion includes a layer of memory foam, a pressure-sensitive soft polyurethane, that recovers its form completely thus giving great comfort
- Loose Seat Cushion (the seat cushions of the model are not fixed to the frame)
- Tight Back Cushion (the back cushions of the models are fixed to the frame)
- Wood Frame
- Without Feet Assembled (the feet will be in a bag inside the package)
- Plastic Wrap (the model will be wrapped in a plastic bag)
- Feet available in metal finishings 77 (Glossy Chromed) / 78 (Glossy Black)
- Feet height 12,5 cm





■ Vers. 446



■ Vers. 446







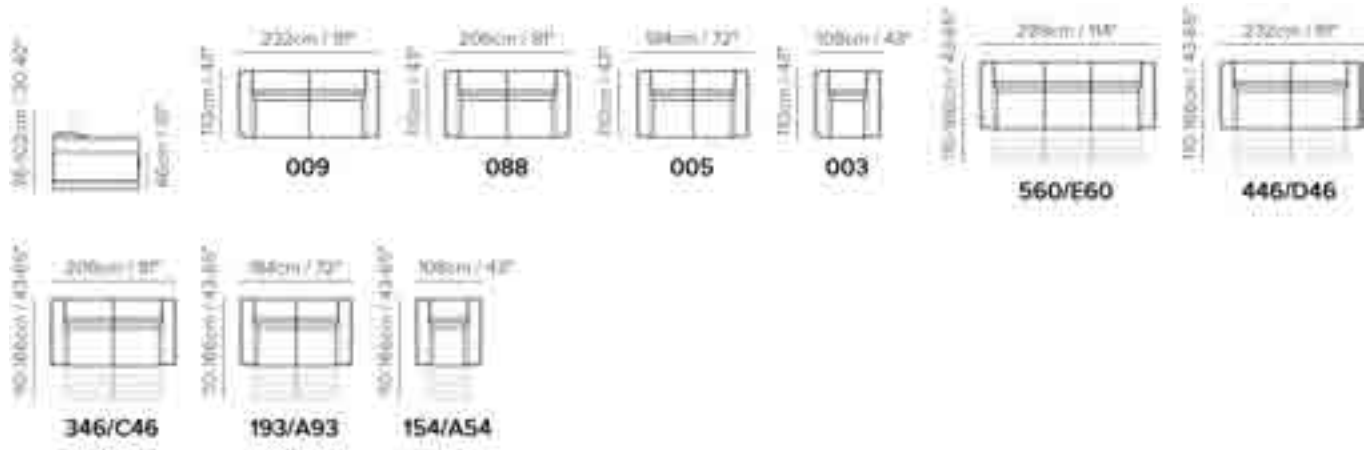

■ Vers. 446

## SCHEMATICS



## TECHNICAL INFORMATION

	<b>COVERING</b>	Leather <input checked="" type="checkbox"/>				
	<b>LEGS</b>	Wood <input type="checkbox"/>	Metal <input checked="" type="checkbox"/>	Plastic <input type="checkbox"/>	Castors <input type="checkbox"/>	Upholstered <input type="checkbox"/>
	<b>FILLING</b>	Arms <input type="checkbox"/> Fiber <input checked="" type="checkbox"/> Foam <input type="checkbox"/> Feather/Fiber Mix <input type="checkbox"/> Feather	Seat cushion <input type="checkbox"/> Fiber <input checked="" type="checkbox"/> Foam <input type="checkbox"/> Feather/Fiber Mix <input type="checkbox"/> Feather	Back cushion <input type="checkbox"/> Fiber <input checked="" type="checkbox"/> Foam <input type="checkbox"/> Feather/Fiber Mix <input type="checkbox"/> Feather		
	<b>COMFORT</b>	Standard Comfort <input checked="" type="checkbox"/>	Firm Comfort <input checked="" type="checkbox"/>			
	<b>FUNCTION</b>	Bed <input type="checkbox"/>	Electric motion <input checked="" type="checkbox"/>	Motion <input type="checkbox"/>	Recliner <input checked="" type="checkbox"/>	Sliding <input type="checkbox"/>
	<b>OPTIONS</b>	Contrast Stitching <input type="checkbox"/>	Removable <input type="checkbox"/>	Nails <input type="checkbox"/>		

## NOTES

- Model also available with thick leather with model code Sxxx (Art. Vesuvio, Cassidy).
- Version 560, a three seater sofa where each seat has its own electric mechanism. The external seats have soft touch buttons on the exterior part of the arm hidden under the covering; the central one has two buttons on the sides of the seat cushion.
- Seat cushion includes a layer of memory foam, a pressure-sensitive soft polyurethane, that recovers its form completely thus giving great comfort
- Adjustable headrest on all versions.
- Tight Seat Cushion (the seat cushions of the models are fixed to the frame)
- Tight Back Cushion (the back cushions of the models are fixed to the frame)
- Wood Frame
- With Feet Assembled (the model will be loaded with feet already mounted on the sofa)
- Plastic Wrap (the model will be wrapped in a plastic bag)
- Feet available in metal finishings 75 (Glazed Nickel) / 78 (Glossy Black)
- Feet height 11,0 cm

NOTES

---





■ Vers. 100



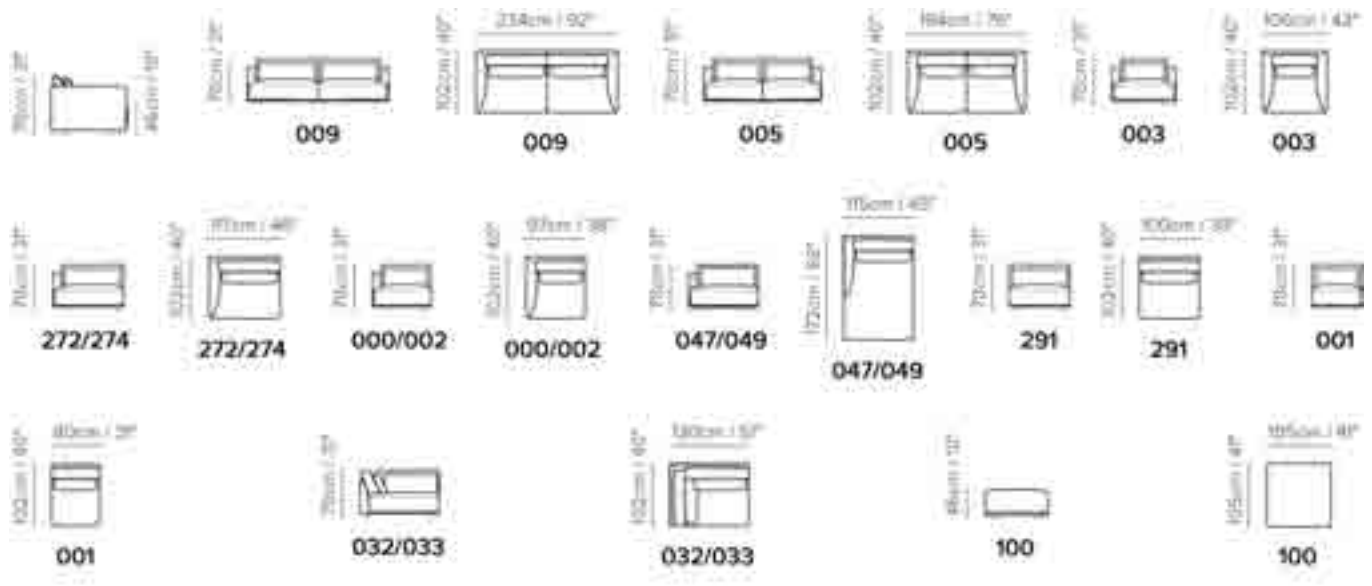



## SCHEMATICS



## COMPOSITION EXAMPLES



## TECHNICAL INFORMATION

	<b>COVERING</b>	Leather <input checked="" type="checkbox"/>				
	<b>LEGS</b>	Wood <input type="checkbox"/>	Metal <input checked="" type="checkbox"/>	Plastic <input type="checkbox"/>	Castors <input type="checkbox"/>	Upholstered <input type="checkbox"/>
	<b>FILLING</b>	Arms <input type="checkbox"/> Fiber <input type="checkbox"/> Foam <input type="checkbox"/> Feather/Fiber Mix <input type="checkbox"/> Feather	Seat cushion <input type="checkbox"/> Fiber <input type="checkbox"/> Foam <input type="checkbox"/> Feather/Fiber Mix <input type="checkbox"/> Feather	Back cushion <input type="checkbox"/> Fiber <input type="checkbox"/> Foam <input type="checkbox"/> Feather/Fiber Mix <input type="checkbox"/> Feather		
	<b>COMFORT</b>	Standard Comfort <input checked="" type="checkbox"/>	Firm Comfort <input type="checkbox"/>			
	<b>FUNCTION</b>	Bed <input type="checkbox"/>	Electric motion <input type="checkbox"/>	Motion <input type="checkbox"/>	Recliner <input type="checkbox"/>	Sliding <input type="checkbox"/>
	<b>OPTIONS</b>	Nails <input type="checkbox"/>	Removable <input type="checkbox"/>	Contrast Stitching <input type="checkbox"/>		

## NOTES

- Loose Seat Cushion (the seat cushions of the model are not fixed to the frame)
- With Leather Side (the sectional pieces come with leather sides)
- Wood Frame
- With Feet Assembled (the model will be loaded with feet already mounted on the sofa)
- Plastic Wrap (the model will be wrapped in a plastic bag)
- Feet available in finishing 11 (Metal)
- Feet height 6,0 / 9,0 cm
- It is possible to change feet height (see user's instructions)

NOTES

---



■ Vers. 064



■ Vers. 064







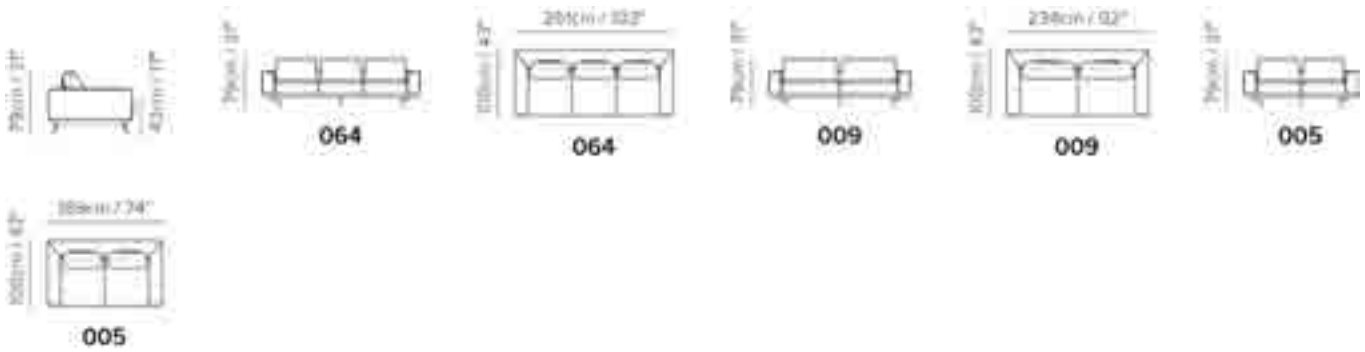

■ Vers. 009

## SCHEMATICS

---



## TECHNICAL INFORMATION

	<b>COVERING</b>	Leather <input checked="" type="checkbox"/>	Soft Cover <input checked="" type="checkbox"/>			
	<b>LEGS</b>	Wood <input checked="" type="checkbox"/> Upholstered <input type="checkbox"/>	Wood <input checked="" type="checkbox"/>	Metal <input type="checkbox"/>	Plastic <input type="checkbox"/>	Castors <input type="checkbox"/>
	<b>FILLING</b>	Arms <input type="checkbox"/> Fiber <input checked="" type="checkbox"/> Foam <input type="checkbox"/> Feather/Fiber Mix <input type="checkbox"/> Feather	Seat cushion <input type="checkbox"/> Fiber <input checked="" type="checkbox"/> Foam <input type="checkbox"/> Feather/Fiber Mix <input checked="" type="checkbox"/> Feather	Back cushion <input type="checkbox"/> Fiber <input checked="" type="checkbox"/> Foam <input type="checkbox"/> Feather/Fiber Mix <input checked="" type="checkbox"/> Feather		
	<b>COMFORT</b>	Standard Comfort <input checked="" type="checkbox"/>	Firm Comfort <input type="checkbox"/>			
	<b>FUNCTION</b>	Bed <input type="checkbox"/>	Electric motion <input type="checkbox"/>	Motion <input type="checkbox"/>	Recliner <input type="checkbox"/>	Sliding <input type="checkbox"/>
	<b>OPTIONS</b>	Contrast Stitching <input type="checkbox"/>	Removable <input type="checkbox"/>	Nails <input type="checkbox"/>		

## NOTES

- Seat cushion includes a layer of memory foam, a pressure-sensitive soft polyurethane, that recovers its form completely thus giving great comfort
- Loose Seat Cushion (the seat cushions of the model are not fixed to the frame)
- Wood Frame
- With Feet Assembled (the model will be loaded with feet already mounted on the sofa)
- Plastic Wrap (the model will be wrapped in a plastic bag)
- Feet available in wood finishings 29 (Coffee) with metal insert 78 (Glossy Black)
- Feet available in wood finishing ZN (Oak Walnut) with metal insert in 75 (Glazed Nickel)

NOTES

---





■ Vers. 003



■ Vers. 003







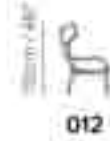

■ Vers. 012

## SCHEMATICS

---



## TECHNICAL INFORMATION

	<b>COVERING</b>	Leather <input checked="" type="checkbox"/>	Soft Cover <input checked="" type="checkbox"/>			
	<b>LEGS</b>	Wood <input checked="" type="checkbox"/>	Metal <input type="checkbox"/>	Plastic <input type="checkbox"/>	Castors <input type="checkbox"/>	Upholstered <input type="checkbox"/>
	<b>FILLING</b>	Arms <input type="checkbox"/> Fiber <input checked="" type="checkbox"/> Foam <input type="checkbox"/> Feather/Fiber Mix <input type="checkbox"/> Feather	Seat cushion <input type="checkbox"/> Fiber <input checked="" type="checkbox"/> Foam <input type="checkbox"/> Feather/Fiber Mix <input type="checkbox"/> Feather	Back cushion <input type="checkbox"/> Fiber <input checked="" type="checkbox"/> Foam <input type="checkbox"/> Feather/Fiber Mix <input type="checkbox"/> Feather		
	<b>COMFORT</b>	Standard Comfort <input checked="" type="checkbox"/>	Firm Comfort <input type="checkbox"/>			
	<b>FUNCTION</b>	Bed <input type="checkbox"/>	Electric motion <input type="checkbox"/>	Motion <input type="checkbox"/>	Recliner <input type="checkbox"/>	Sliding <input type="checkbox"/>
	<b>OPTIONS</b>	Nails <input type="checkbox"/>	Removable <input type="checkbox"/>	Contrast Stitching <input type="checkbox"/>		

## NOTES

- Loose Seat Cushion (the seat cushions of the model are not fixed to the frame)
- With Feet Assembled (the model will be loaded with feet already mounted on the sofa)
- Plastic Wrap (the model will be wrapped in a plastic bag)
- Feet available in wood finishing 29 (Coffee) / ZN (Oak Walnut)

NOTES

---



■ Vers. 009



■ Vers. 009







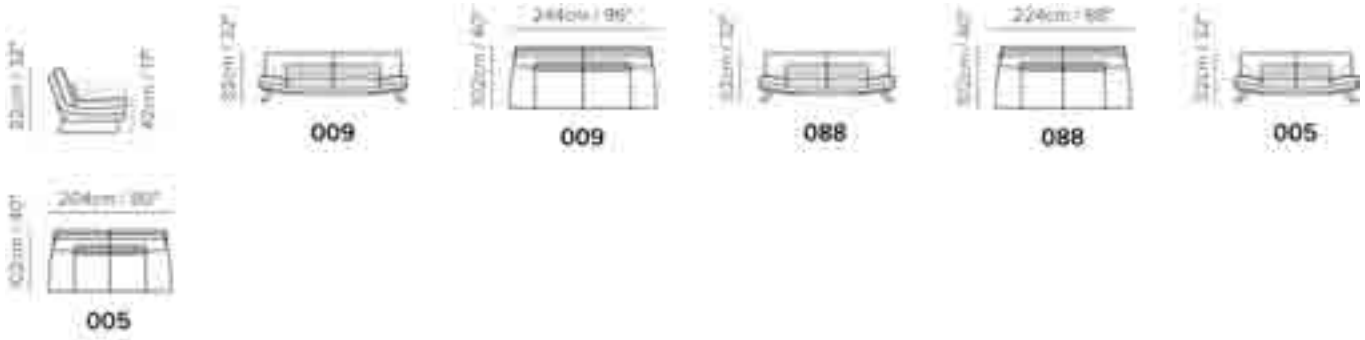

■ Vers. 009

## SCHEMATICS

---



## TECHNICAL INFORMATION

	<b>COVERING</b>	Leather <input checked="" type="checkbox"/>					
	<b>LEGS</b>	Wood <input type="checkbox"/>	Metal <input checked="" type="checkbox"/>	Plastic <input type="checkbox"/>	Castors <input type="checkbox"/>	Upholstered <input type="checkbox"/>	
	<b>FILLING</b>	Arms <input type="checkbox"/> Fiber <input checked="" type="checkbox"/> Foam <input type="checkbox"/> Feather/Fiber Mix <input type="checkbox"/> Feather	Seat cushion <input type="checkbox"/> Fiber <input checked="" type="checkbox"/> Foam <input type="checkbox"/> Feather/Fiber Mix <input type="checkbox"/> Feather	Back cushion <input type="checkbox"/> Fiber <input checked="" type="checkbox"/> Foam <input type="checkbox"/> Feather/Fiber Mix <input type="checkbox"/> Feather			
	<b>COMFORT</b>	Standard Comfort <input checked="" type="checkbox"/>	Firm Comfort <input checked="" type="checkbox"/>				
	<b>FUNCTION</b>	Bed <input type="checkbox"/>	Electric motion <input type="checkbox"/>	Motion <input type="checkbox"/>	Recliner <input type="checkbox"/>	Sliding <input type="checkbox"/>	
	<b>OPTIONS</b>	Contrast Stitching <input type="checkbox"/>	Removable <input type="checkbox"/>	Nails <input type="checkbox"/>			

## NOTES

- Seat cushion includes a layer of memory foam, a pressure-sensitive soft polyurethane, that recovers its form completely thus giving great comfort
- Loose Seat Cushion (the seat cushions of the model are not fixed to the frame)
- Back Cushion Zippered (the back cushion is attached to the frame through a zipper)
- Wood Frame
- With Feet Assembled (the model will be loaded with feet already mounted on the sofa)
- Plastic Wrap (the model will be wrapped in a plastic bag)
- Feet available in metal finishing 78 (Glossy Black)
- Feet height 21,0 cm

NOTES

---





■ Vers. 458



■ Vers. 458









■ Vers. 448+029+291+049

## SCHEMATICS



## TECHNICAL INFORMATION

	<b>COVERING</b>	Leather <input checked="" type="checkbox"/>				
	<b>LEGS</b>	Wood <input checked="" type="checkbox"/>	Metal <input type="checkbox"/>	Plastic <input type="checkbox"/>	Castors <input type="checkbox"/>	Upholstered <input type="checkbox"/>
	<b>FILLING</b>	Arms <input type="checkbox"/> Fiber <input checked="" type="checkbox"/> Foam <input type="checkbox"/> Feather/Fiber Mix <input type="checkbox"/> Feather	Seat cushion <input type="checkbox"/> Fiber <input checked="" type="checkbox"/> Foam <input type="checkbox"/> Feather/Fiber Mix <input type="checkbox"/> Feather	Back cushion <input type="checkbox"/> Fiber <input checked="" type="checkbox"/> Foam <input type="checkbox"/> Feather/Fiber Mix <input type="checkbox"/> Feather		
	<b>COMFORT</b>	Standard Comfort <input checked="" type="checkbox"/>	Firm Comfort <input checked="" type="checkbox"/>			
	<b>FUNCTION</b>	Bed <input type="checkbox"/>	Electric motion <input checked="" type="checkbox"/>	Motion <input type="checkbox"/>	Recliner <input checked="" type="checkbox"/>	Sliding <input type="checkbox"/>
	<b>OPTIONS</b>	Nails <input type="checkbox"/>	Removable <input type="checkbox"/>	Contrast Stitching <input checked="" type="checkbox"/>		

## NOTES

- Contrast stitching is available only with certain covers and option is managed directly in NARES.
- Tight Seat Cushion (the seat cushions of the models are fixed to the frame)
- Tight Back Cushion (the back cushions of the models are fixed to the frame)
- Wood Frame
- Without Feet Assembled (the feet will be in a bag inside the package)
- Plastic Wrap (the model will be wrapped in a plastic bag)
- Feet available in wood finishings 09 (Walnut) / 18 (Wengè)
- Feet height 4,5 cm
- TWO TONE COVERING OPTIONS:
- 1° COV. = Frame, seat and back cushions
- 2° COV. = Backrest and arm detail

NOTES

---



■ Vers. 009



■ Vers. 005







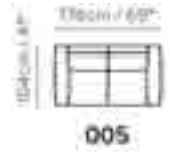
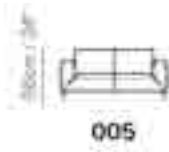
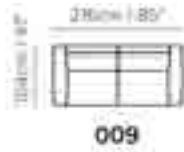
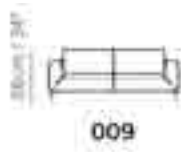

■ Vers. 003

## SCHEMATICS

---



## TECHNICAL INFORMATION

	<b>COVERING</b>	Leather <input checked="" type="checkbox"/>	Soft Cover <input checked="" type="checkbox"/>			
	<b>LEGS</b>	Wood <input type="checkbox"/>	Metal <input checked="" type="checkbox"/>	Plastic <input type="checkbox"/>	Castors <input type="checkbox"/>	Upholstered <input type="checkbox"/>
	<b>FILLING</b>	Arms <input type="checkbox"/> Fiber <input checked="" type="checkbox"/> Foam <input type="checkbox"/> Feather/Fiber Mix <input type="checkbox"/> Feather	Seat cushion <input type="checkbox"/> Fiber <input checked="" type="checkbox"/> Foam <input type="checkbox"/> Feather/Fiber Mix <input type="checkbox"/> Feather	Back cushion <input type="checkbox"/> Fiber <input checked="" type="checkbox"/> Foam <input type="checkbox"/> Feather/Fiber Mix <input type="checkbox"/> Feather		
	<b>COMFORT</b>	Standard Comfort <input checked="" type="checkbox"/>	Firm Comfort <input checked="" type="checkbox"/>			
	<b>FUNCTION</b>	Bed <input type="checkbox"/>	Electric motion <input type="checkbox"/>	Motion <input type="checkbox"/>	Recliner <input type="checkbox"/>	Sliding <input type="checkbox"/>
	<b>OPTIONS</b>	Contrast Stitching <input type="checkbox"/>	Removable <input type="checkbox"/>	Nails <input type="checkbox"/>		

## NOTES

- Tight Seat Cushion (the seat cushions of the models are fixed to the frame)
- Back Cushion Zippered (the back cushion is attached to the frame through a zipper)
- Wood Frame
- Without Feet Assembled (the feet will be in a bag inside the package)
- Plastic Wrap (the model will be wrapped in a plastic bag)
- Feet available in metal finishings 77 (Glossy Chromed) / 78 (Glossy Black)
- Feet height 15,0 cm

NOTES

---





■ Vers. 009



■ Vers. 005







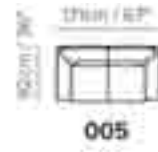
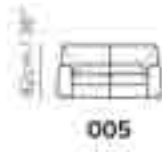
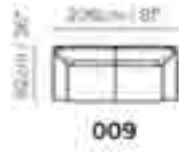
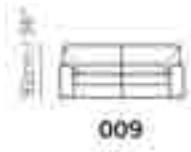

■ Vers. 003

## SCHEMATICS

---



## TECHNICAL INFORMATION

	<b>COVERING</b>	Leather <input checked="" type="checkbox"/>	Soft Cover <input checked="" type="checkbox"/>			
	<b>LEGS</b>	Wood <input checked="" type="checkbox"/>	Metal <input type="checkbox"/>	Plastic <input type="checkbox"/>	Castors <input type="checkbox"/>	Upholstered <input type="checkbox"/>
	<b>FILLING</b>	Arms <input type="checkbox"/> Fiber <input checked="" type="checkbox"/> Foam <input type="checkbox"/> Feather/Fiber Mix <input type="checkbox"/> Feather	Seat cushion <input type="checkbox"/> Fiber <input checked="" type="checkbox"/> Foam <input type="checkbox"/> Feather/Fiber Mix <input type="checkbox"/> Feather	Back cushion <input type="checkbox"/> Fiber <input checked="" type="checkbox"/> Foam <input type="checkbox"/> Feather/Fiber Mix <input type="checkbox"/> Feather		
	<b>COMFORT</b>	Standard Comfort <input checked="" type="checkbox"/>	Firm Comfort <input checked="" type="checkbox"/>			
	<b>FUNCTION</b>	Bed <input type="checkbox"/>	Electric motion <input type="checkbox"/>	Motion <input type="checkbox"/>	Recliner <input type="checkbox"/>	Sliding <input type="checkbox"/>
	<b>OPTIONS</b>	Nails <input type="checkbox"/>	Removable <input type="checkbox"/>	Contrast Stitching <input type="checkbox"/>		

## NOTES

- Tight Seat Cushion (the seat cushions of the models are fixed to the frame)
- Tight Back Cushion (the back cushions of the models are fixed to the frame)
- Wood Frame
- Without Feet Assembled (the feet will be in a bag inside the package)
- Plastic Wrap (the model will be wrapped in a plastic bag)
- Feet available in wood finishings 09 (Walnut) / 18 (Wengè)
- Feet height 9,5 cm

NOTES

---



■ Vers. 450+338+452



■ Vers. 450+338+452



■ Vers. 450+452



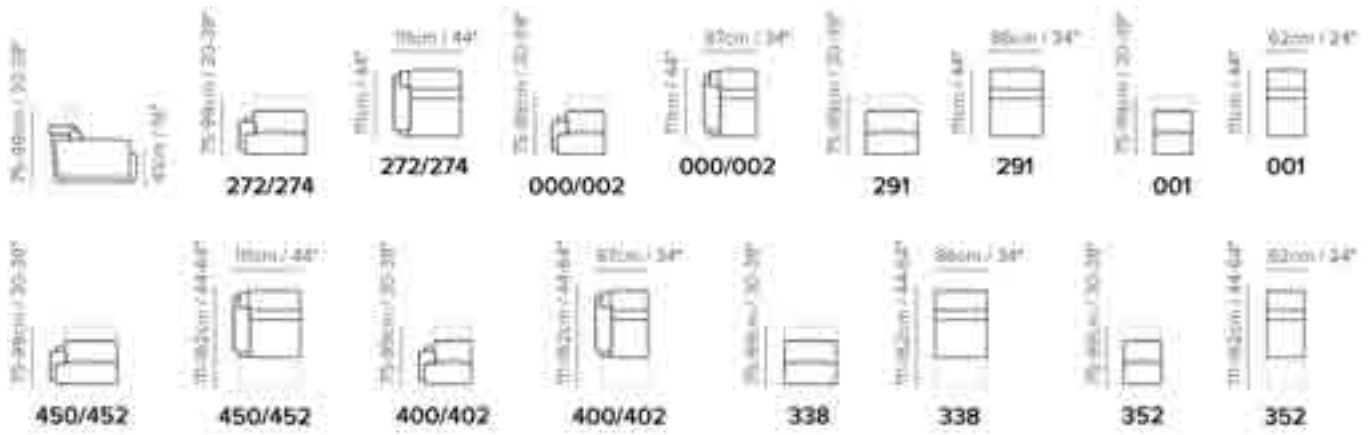

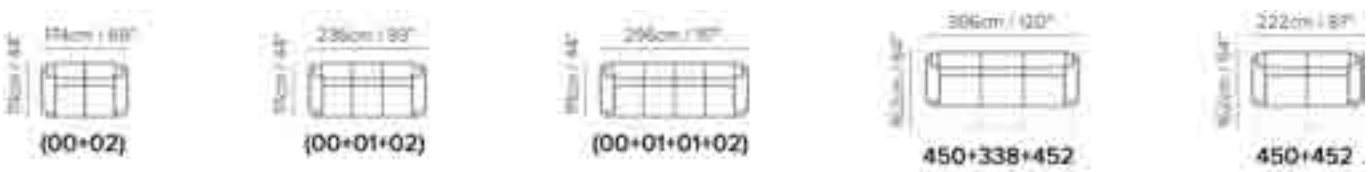

## SCHEMATICS



## COMPOSITION EXAMPLES



## TECHNICAL INFORMATION

	<b>COVERING</b>	Leather <input checked="" type="checkbox"/>	Soft Cover <input checked="" type="checkbox"/>				
	<b>LEGS</b>	Wood <input type="checkbox"/>	Metal <input type="checkbox"/>	Plastic <input checked="" type="checkbox"/>	Castors <input type="checkbox"/>	Upholstered <input type="checkbox"/>	
	<b>FILLING</b>	Arms <input type="checkbox"/>	Fiber <input type="checkbox"/> Foam <input type="checkbox"/> Feather/Fiber Mix <input type="checkbox"/> Feather <input type="checkbox"/>	Seat cushion <input type="checkbox"/>	Fiber <input type="checkbox"/> Foam <input type="checkbox"/> Feather/Fiber Mix <input type="checkbox"/> Feather <input type="checkbox"/>	Back cushion <input type="checkbox"/>	Fiber <input type="checkbox"/> Foam <input type="checkbox"/> Feather/Fiber Mix <input type="checkbox"/> Feather <input type="checkbox"/>
	<b>COMFORT</b>	Standard Comfort <input checked="" type="checkbox"/>	Firm Comfort <input checked="" type="checkbox"/>				
	<b>FUNCTION</b>	Bed <input type="checkbox"/>	Electric motion <input checked="" type="checkbox"/>	Motion <input type="checkbox"/>	Recliner <input type="checkbox"/>	Sliding <input type="checkbox"/>	
	<b>OPTIONS</b>	Contrast Stitching <input type="checkbox"/>	Removable <input type="checkbox"/>	Nails <input type="checkbox"/>			

## NOTES

- Tight Seat Cushion (the seat cushions of the models are fixed to the frame)
- Tight Back Cushion (the back cushions of the models are fixed to the frame)
- No Leather Side (the sectional pieces have the side covered with fabric and not leather)
- Wood Frame
- Without Feet Assembled (the feet will be in a bag inside the package)
- Plastic Wrap (the model will be wrapped in a plastic bag)
- Feet height 5,0 cm

NOTES

---





■ Vers. 009



■ Vers. 009







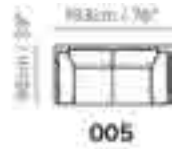
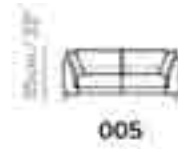
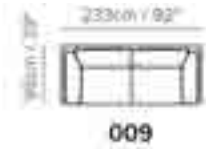
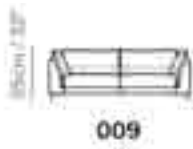

■ Vers. 009

## SCHEMATICS

---



## TECHNICAL INFORMATION

	<b>COVERING</b>	Leather <input checked="" type="checkbox"/>	Soft Cover <input checked="" type="checkbox"/>			
	<b>LEGS</b>	Wood <input checked="" type="checkbox"/>	Metal <input type="checkbox"/>	Plastic <input type="checkbox"/>	Castors <input type="checkbox"/>	Upholstered <input type="checkbox"/>
	<b>FILLING</b>	Arms	<input type="checkbox"/> Fiber <input type="checkbox"/> Foam <input type="checkbox"/> Feather/Fiber Mix <input type="checkbox"/> Feather	Seat cushion	<input type="checkbox"/> Fiber <input type="checkbox"/> Foam <input type="checkbox"/> Feather/Fiber Mix <input type="checkbox"/> Feather	Back cushion <input type="checkbox"/> Fiber <input type="checkbox"/> Foam <input type="checkbox"/> Feather/Fiber Mix <input type="checkbox"/> Feather
	<b>COMFORT</b>	Standard Comfort <input checked="" type="checkbox"/>	Firm Comfort <input type="checkbox"/>			
	<b>FUNCTION</b>	Bed <input type="checkbox"/>	Electric motion <input type="checkbox"/>	Motion <input type="checkbox"/>	Recliner <input type="checkbox"/>	Sliding <input type="checkbox"/>
	<b>OPTIONS</b>	Nails <input type="checkbox"/>	Removable <input type="checkbox"/>	Contrast Stitching <input type="checkbox"/>		

## NOTES

- Tight Seat Cushion (the seat cushions of the models are fixed to the frame)
- Tight Back Cushion (the back cushions of the models are fixed to the frame)
- Wood Frame
- Without Feet Assembled (the feet will be in a bag inside the package)
- Plastic Wrap (the model will be wrapped in a plastic bag)
- Feet available in wood finishings 09 (Walnut) / 18 (Wengè)
- Feet height 12,0 cm

NOTES

---



■ Vers. 008



■ Vers. 008







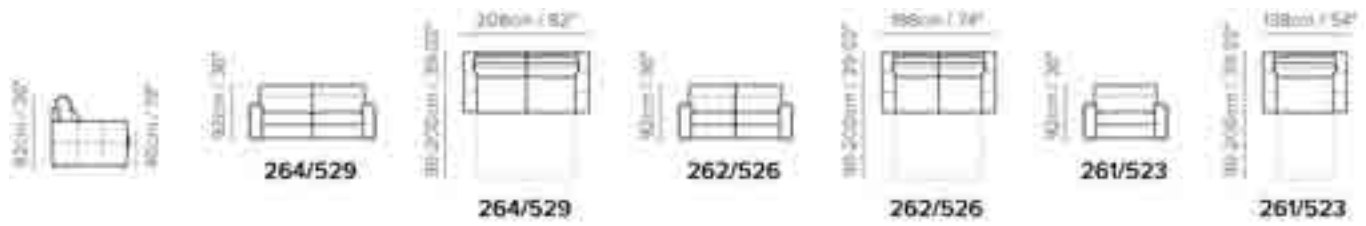

■ Vers. 008

## SCHEMATICS



## TECHNICAL INFORMATION

	<b>COVERING</b>	Leather <input checked="" type="checkbox"/>				
	<b>LEGS</b>	Wood <input checked="" type="checkbox"/>	Metal <input type="checkbox"/>	Plastic <input type="checkbox"/>	Castors <input type="checkbox"/>	Upholstered <input type="checkbox"/>
	<b>FILLING</b>	Arms <input type="checkbox"/> Fiber <input type="checkbox"/> Foam <input type="checkbox"/> Feather/Fiber Mix <input type="checkbox"/> Feather	Seat cushion <input type="checkbox"/> Fiber <input type="checkbox"/> Foam <input type="checkbox"/> Feather/Fiber Mix <input type="checkbox"/> Feather	Back cushion <input type="checkbox"/> Fiber <input type="checkbox"/> Foam <input type="checkbox"/> Feather/Fiber Mix <input type="checkbox"/> Feather		
	<b>COMFORT</b>	Standard Comfort <input checked="" type="checkbox"/>	Firm Comfort <input type="checkbox"/>			
	<b>FUNCTION</b>	Bed <input checked="" type="checkbox"/>	Electric motion <input type="checkbox"/>	Motion <input type="checkbox"/>	Recliner <input type="checkbox"/>	Sliding <input type="checkbox"/>
	<b>OPTIONS</b>	Contrast Stitching <input checked="" type="checkbox"/>	Removable <input type="checkbox"/>	Nails <input type="checkbox"/>		

## BED MECHANISM & MATTRESS

MECHANISM		MATTRESS		
VERSIONS	TYPE	VERSIONS	TYPE	DIMENSIONS
				W L H
261,523	Ready-Bed electro-welded - Double folding	523	Memory	70 185 11
262,526	Ready-Bed electro-welded - Double folding	261	GREENPLUS	70 195 11
264,529	Ready-Bed electro-welded - Double folding	262	GREENPLUS	120 195 11
		526	Memory	120 195 11
		264	GREENPLUS	140 195 11
		529	Memory	140 195 11

### Ready-Bed electro-welded

The back cushion goes under the bed mechanism which contains a set of pillow holder.

### Memory

Non-allergic memory mattress available with zippered cover that can be easily taken off and washed.

### GREENPLUS

GREENPLUS mattress is a patented, innovative product. It is ecological, made up of microporous elastomers. It has a great adaptation capacity to the various body pressure which gives big support to the spine. It is antibacterial and no-allergic.

## NOTES

- Contrast stitching is available only with certain covers and option is managed directly in NARES.
- Seat cushion zippered (the seat cushion is attached to the frame through a zipper)
- Tight Back Cushion (the back cushions of the models are fixed to the frame)
- Wood Frame
- With Feet Assembled (the model will be loaded with feet already mounted on the sofa)
- Plastic Wrap (the model will be wrapped in a plastic bag)
- Feet available in wood finishings 09 (Walnut) / 18 (Wengè)
- Feet height 4,0 cm

NOTES

---





■ Vers. 446



■ Vers. 446







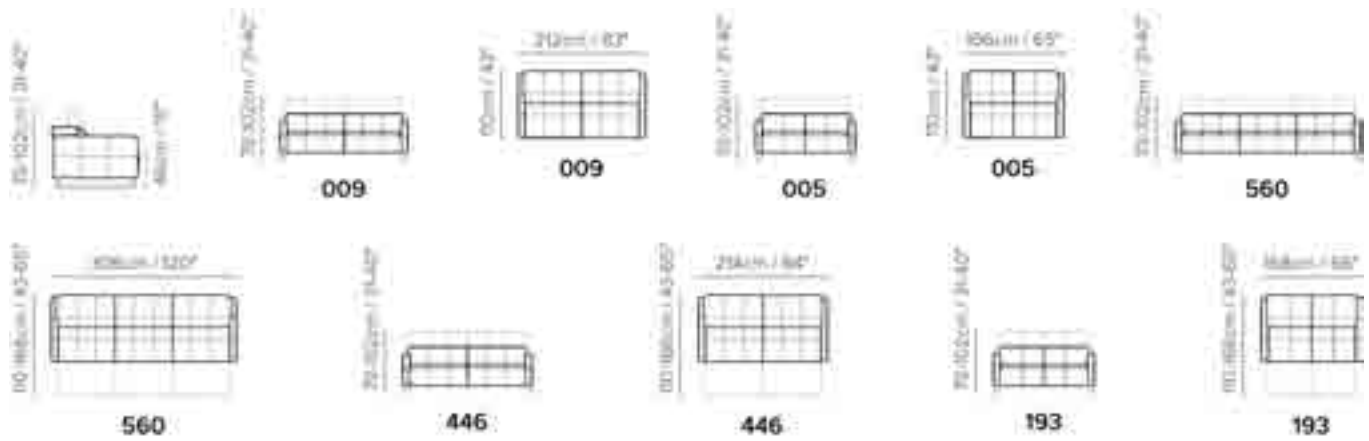

■ Vers. 446

## SCHEMATICS



## TECHNICAL INFORMATION

	<b>COVERING</b>	Leather <input checked="" type="checkbox"/>					
	<b>LEGS</b>	Wood <input type="checkbox"/>	Metal <input checked="" type="checkbox"/>	Plastic <input type="checkbox"/>	Castors <input type="checkbox"/>	Upholstered <input type="checkbox"/>	
	<b>FILLING</b>	Arms	<input type="checkbox"/> Fiber <input type="checkbox"/> Foam <input type="checkbox"/> Feather/Fiber Mix <input type="checkbox"/> Feather	Seat cushion	<input type="checkbox"/> Fiber <input type="checkbox"/> Foam <input type="checkbox"/> Feather/Fiber Mix <input type="checkbox"/> Feather	Back cushion	<input type="checkbox"/> Fiber <input type="checkbox"/> Foam <input type="checkbox"/> Feather/Fiber Mix <input type="checkbox"/> Feather
	<b>COMFORT</b>	Standard Comfort <input checked="" type="checkbox"/>	Firm Comfort <input type="checkbox"/>				
	<b>FUNCTION</b>	Bed <input type="checkbox"/>	Electric motion <input checked="" type="checkbox"/>	Motion <input type="checkbox"/>	Recliner <input type="checkbox"/>	Sliding <input type="checkbox"/>	
	<b>OPTIONS</b>	Nails <input type="checkbox"/>	Removable <input type="checkbox"/>	Contrast Stitching <input type="checkbox"/>			

## NOTES

- Tight Seat Cushion (the seat cushions of the models are fixed to the frame)
- Tight Back Cushion (the back cushions of the models are fixed to the frame)
- Wood Frame
- Without Feet Assembled (the feet will be in a bag inside the package)
- Plastic Wrap (the model will be wrapped in a plastic bag)
- Feet available in metal finishings 77 (Glossy Chromed) / 78 (Glossy Black)
- Feet height 13,0 cm

NOTES

---







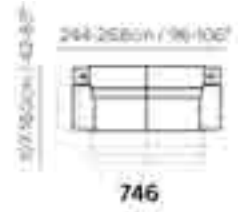
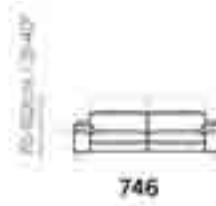

■ Vers. 009

## SCHEMATICS

---



## TECHNICAL INFORMATION

	<b>COVERING</b>	Leather <input checked="" type="checkbox"/>				
	<b>LEGS</b>	Wood <input type="checkbox"/>	Metal <input checked="" type="checkbox"/>	Plastic <input type="checkbox"/>	Castors <input type="checkbox"/>	Upholstered <input type="checkbox"/>
	<b>FILLING</b>	Arms <input type="checkbox"/> Fiber <input type="checkbox"/> Foam <input type="checkbox"/> Feather/Fiber Mix <input type="checkbox"/> Feather	Seat cushion <input type="checkbox"/> Fiber <input type="checkbox"/> Foam <input type="checkbox"/> Feather/Fiber Mix <input type="checkbox"/> Feather	Back cushion <input type="checkbox"/> Fiber <input type="checkbox"/> Foam <input type="checkbox"/> Feather/Fiber Mix <input type="checkbox"/> Feather		
	<b>COMFORT</b>	Standard Comfort <input checked="" type="checkbox"/>	Firm Comfort <input checked="" type="checkbox"/>			
	<b>FUNCTION</b>	Bed <input type="checkbox"/>	Electric motion <input type="checkbox"/>	Motion <input type="checkbox"/>	Recliner <input type="checkbox"/>	Sliding <input type="checkbox"/>
	<b>OPTIONS</b>	Contrast Stitching <input type="checkbox"/>	Removable <input type="checkbox"/>	Nails <input type="checkbox"/>		

## NOTES

- Tight Seat Cushion (the seat cushions of the models are fixed to the frame)
- Tight Back Cushion (the back cushions of the models are fixed to the frame)
- Wood Frame
- Without Feet Assembled (the feet will be in a bag inside the package)
- Plastic Wrap (the model will be wrapped in a plastic bag)
- Feet available in metal finishings 77 (Glossy Chromed) / 78 (Glossy Black)
- Feet height 13,0 cm

NOTES

---





■ vers. 225 + 198 + 225



■ vers. 225 + 198 + 049



■ vers. 223 + 198 + 223



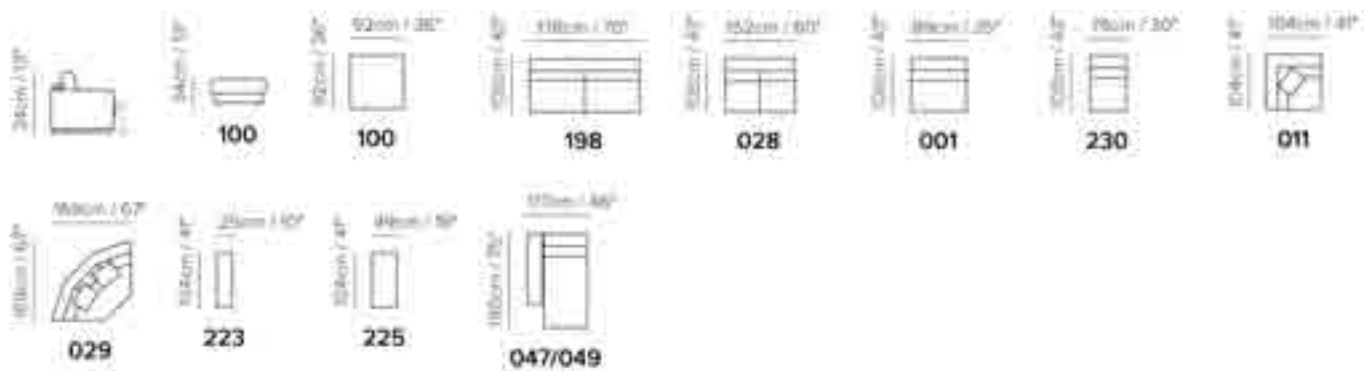

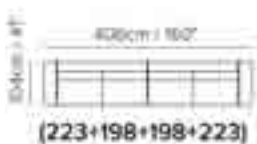
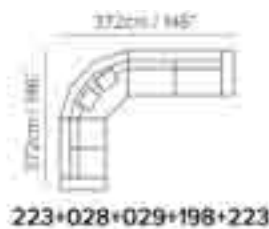

## SCHEMATICS



## COMPOSITION EXAMPLES



## TECHNICAL INFORMATION

	<b>COVERING</b>	Soft Cover <input checked="" type="checkbox"/>					
	<b>LEGS</b>	Wood <input checked="" type="checkbox"/>	Metal <input type="checkbox"/>	Plastic <input type="checkbox"/>	Castors <input type="checkbox"/>	Upholstered <input type="checkbox"/>	
	<b>FILLING</b>	Arms	<input type="checkbox"/> Fiber <input checked="" type="checkbox"/> Foam <input type="checkbox"/> Feather/Fiber Mix <input type="checkbox"/> Feather	Seat cushion	<input type="checkbox"/> Fiber <input checked="" type="checkbox"/> Foam <input checked="" type="checkbox"/> Feather/Fiber Mix <input type="checkbox"/> Feather	Back cushion	<input type="checkbox"/> Fiber <input checked="" type="checkbox"/> Foam <input checked="" type="checkbox"/> Feather/Fiber Mix <input type="checkbox"/> Feather
	<b>COMFORT</b>	Standard Comfort <input checked="" type="checkbox"/>	Firm Comfort <input checked="" type="checkbox"/>				
	<b>FUNCTION</b>	Bed <input type="checkbox"/>	Electric motion <input type="checkbox"/>	Motion <input type="checkbox"/>	Recliner <input type="checkbox"/>	Sliding <input type="checkbox"/>	
	<b>OPTIONS</b>	Nails <input type="checkbox"/>	Removable <input checked="" type="checkbox"/>	Contrast Stitching <input type="checkbox"/>			

## NOTES

- Firm comfort option is available only for Italy.
- Model is not available with article Rossetti.
- Loose Seat Cushion (the seat cushions of the model are not fixed to the frame)
- Seat cushion includes a layer of memory foam, a pressure-sensitive soft polyurethane, that recovers its form completely thus giving great comfort
- With Fabric Side (the sectional pieces come with fabric sides)
- Wood Frame
- Without Feet Assembled (the feet will be in a bag inside the package)
- Plastic Wrap (the model will be wrapped in a plastic bag)
- Feet available in wood finishings 09 (Walnut) / 18 (Wengè)
- Feet height 6,5 cm
- Version 011 includes 1 small cushion.
- Version 029 includes 2 small cushions.

NOTES

---



■ vers. 000 + 001 + 002



■ vers. 000 + 001 + 011 + 001 + 001 + 100 + 112



■ vers. 000 + 001 + 011 + 001 + 001 + 100 + 112



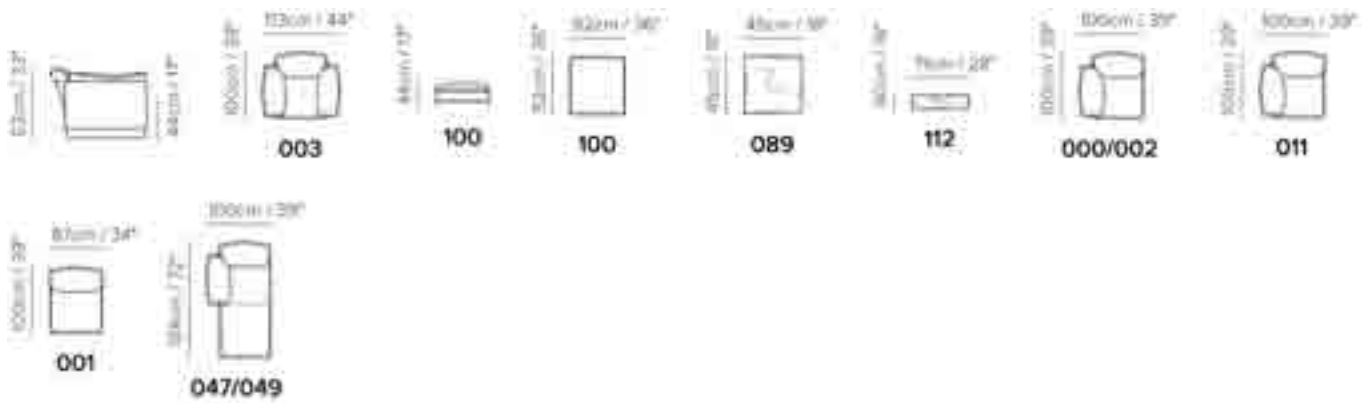

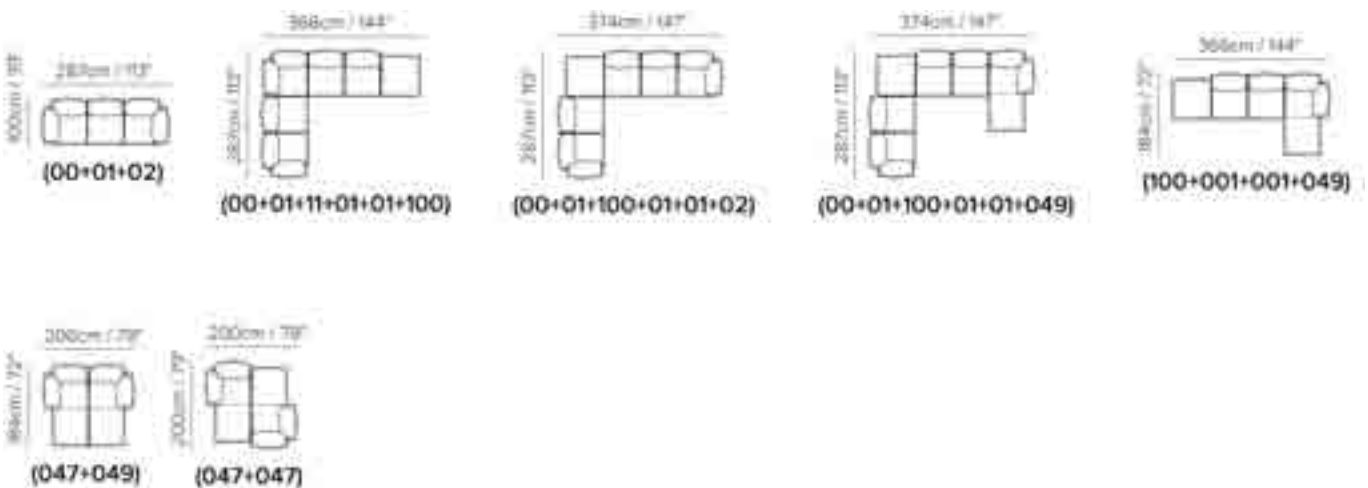

## SCHEMATICS



## COMPOSITION EXAMPLES



## TECHNICAL INFORMATION

	<b>COVERING</b>	Soft Cover <input checked="" type="checkbox"/>					
	<b>LEGS</b>	Wood <input type="checkbox"/>	Metal <input checked="" type="checkbox"/>	Plastic <input type="checkbox"/>	Castors <input type="checkbox"/>	Upholstered <input type="checkbox"/>	
	<b>FILLING</b>	Arms	<input type="checkbox"/> Fiber <input checked="" type="checkbox"/> Foam <input type="checkbox"/> Feather/Fiber Mix <input checked="" type="checkbox"/> Feather	Seat cushion	<input type="checkbox"/> Fiber <input checked="" type="checkbox"/> Foam <input type="checkbox"/> Feather/Fiber Mix <input checked="" type="checkbox"/> Feather	Back cushion	<input type="checkbox"/> Fiber <input checked="" type="checkbox"/> Foam <input type="checkbox"/> Feather/Fiber Mix <input checked="" type="checkbox"/> Feather
	<b>COMFORT</b>	Standard Comfort <input checked="" type="checkbox"/>	Firm Comfort <input type="checkbox"/>				
	<b>FUNCTION</b>	Bed <input type="checkbox"/>	Electric motion <input type="checkbox"/>	Motion <input type="checkbox"/>	Recliner <input type="checkbox"/>	Sliding <input type="checkbox"/>	
	<b>OPTIONS</b>	Contrast Stitching <input type="checkbox"/>	Removable <input checked="" type="checkbox"/>	Nails <input type="checkbox"/>			

## NOTES

- Model is not available with article Rossetti.
- Seat cushion includes a layer of memory foam, a pressure-sensitive soft polyurethane, that recovers its form completely thus giving great comfort
- Loose Seat Cushion (the seat cushions of the model are not fixed to the frame)
- With Fabric Side (the sectional pieces come with fabric sides)
- Wood Frame
- Without Feet Assembled (the feet will be in a bag inside the package)
- Plastic Wrap (the model will be wrapped in a plastic bag)
- Feet available in metal finishing 75 (Glazed Nickel)
- Feet height 12,5 cm
- TWO TONE COVERING OPTIONS IN FABRIC:
- 1° COV. = Frame and flange edge
- 2° COV. = Arms, seat and back cushions

NOTES

---





■ vers. 003



■ vers. 003









■ vers. 003

## SCHEMATICS

---



## TECHNICAL INFORMATION

	<b>COVERING</b>	Soft Cover <input checked="" type="checkbox"/>				
	<b>LEGS</b>	Wood <input checked="" type="checkbox"/>	Metal <input type="checkbox"/>	Plastic <input type="checkbox"/>	Castors <input type="checkbox"/>	Upholstered <input type="checkbox"/>
	<b>FILLING</b>	Arms <input type="checkbox"/> Fiber <input checked="" type="checkbox"/> Foam <input type="checkbox"/> Feather/Fiber Mix <input type="checkbox"/> Feather	Seat cushion <input type="checkbox"/> Fiber <input checked="" type="checkbox"/> Foam <input type="checkbox"/> Feather/Fiber Mix <input type="checkbox"/> Feather	Back cushion <input type="checkbox"/> Fiber <input checked="" type="checkbox"/> Foam <input type="checkbox"/> Feather/Fiber Mix <input type="checkbox"/> Feather		
	<b>COMFORT</b>	Standard Comfort <input checked="" type="checkbox"/>	Firm Comfort <input type="checkbox"/>			
	<b>FUNCTION</b>	Bed <input type="checkbox"/>	Electric motion <input type="checkbox"/>	Motion <input type="checkbox"/>	Recliner <input type="checkbox"/>	Sliding <input type="checkbox"/>
	<b>OPTIONS</b>	Nails <input type="checkbox"/>	Removable <input checked="" type="checkbox"/>	Contrast Stitching <input type="checkbox"/>		

## NOTES

- Model available with accents fabric Retrò.
- Model is not available with article Rossetti.
- Tight Seat Cushion (the seat cushions of the models are fixed to the frame)
- Tight Back Cushion (the back cushions of the models are fixed to the frame)
- Wood Frame
- Without Feet Assembled (the feet will be in a bag inside the package)
- Plastic Wrap (the model will be wrapped in a plastic bag)
- Front feet are slightly higher in respect to rear.
- Feet available in wood finishings 09 (Walnut) / 18 (Wengè)
- Feet height 13,0/8,0 cm

NOTES

---



■ vers. 000 + 001 + 049



■ vers. 000 + 001 + 049



■ vers. 000 + 001 + 011 + 001 + 073



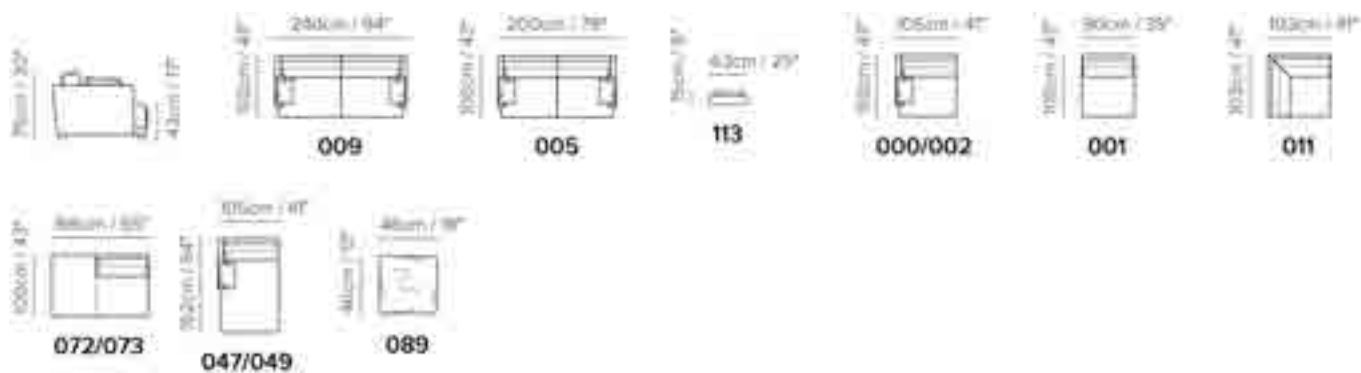



## SCHEMATICS



## COMPOSITION EXAMPLES



## TECHNICAL INFORMATION

	<b>COVERING</b>	Soft Cover <input checked="" type="checkbox"/>					
	<b>LEGS</b>	Wood <input checked="" type="checkbox"/>	Metal <input type="checkbox"/>	Plastic <input type="checkbox"/>	Castors <input type="checkbox"/>	Upholstered <input type="checkbox"/>	
	<b>FILLING</b>	Arms	<input type="checkbox"/> Fiber <input checked="" type="checkbox"/> Foam <input type="checkbox"/> Feather/Fiber Mix <input type="checkbox"/> Feather	Seat cushion	<input type="checkbox"/> Fiber <input checked="" type="checkbox"/> Foam <input checked="" type="checkbox"/> Feather/Fiber Mix <input type="checkbox"/> Feather	Back cushion	<input type="checkbox"/> Fiber <input checked="" type="checkbox"/> Foam <input checked="" type="checkbox"/> Feather/Fiber Mix <input type="checkbox"/> Feather
	<b>COMFORT</b>	Standard Comfort <input checked="" type="checkbox"/>	Firm Comfort <input type="checkbox"/>				
	<b>FUNCTION</b>	Bed <input type="checkbox"/>	Electric motion <input type="checkbox"/>	Motion <input type="checkbox"/>	Recliner <input type="checkbox"/>	Sliding <input type="checkbox"/>	
	<b>OPTIONS</b>	Contrast Stitching <input type="checkbox"/>	Removable <input checked="" type="checkbox"/>	Nails <input type="checkbox"/>			

## NOTES

- Model is not available with article Rossetti.
- Seat cushion includes a layer of memory foam, a pressure-sensitive soft polyurethane, that recovers its form completely thus giving great comfort
- Loose Seat Cushion (the seat cushions of the model are not fixed to the frame)
- With Fabric Side (the sectional pieces come with fabric sides)
- Wood Frame
- Without Feet Assembled (the feet will be in a bag inside the package)
- Plastic Wrap (the model will be wrapped in a plastic bag)
- Feet available in wood finishing 28 (Grey)
- Feet height 5,5 cm
- Versions 000/002/047/049 include 1 small cushion.
- Versions 005/009 include 2 small cushions.
- Second option version 233 has higher back seat. The headrest is not adjustable.

NOTES

---





■ Vers. 272+274



■ Vers. 272+274



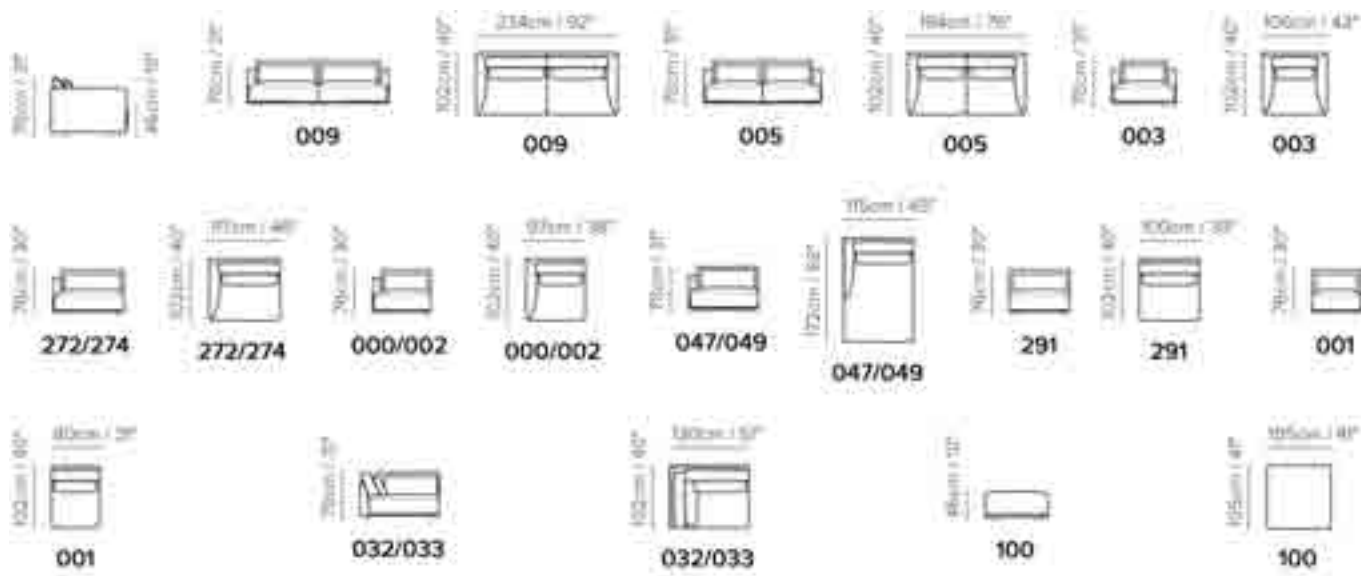



## SCHEMATICS



## COMPOSITION EXAMPLES



## TECHNICAL INFORMATION

	<b>COVERING</b>	Soft Cover <input checked="" type="checkbox"/>					
	<b>LEGS</b>	Wood <input type="checkbox"/>	Metal <input checked="" type="checkbox"/>	Plastic <input type="checkbox"/>	Castors <input type="checkbox"/>	Upholstered <input type="checkbox"/>	
	<b>FILLING</b>	Arms	<input type="checkbox"/> Fiber <input checked="" type="checkbox"/> Foam <input type="checkbox"/> Feather/Fiber Mix <input type="checkbox"/> Feather	Seat cushion	<input type="checkbox"/> Fiber <input checked="" type="checkbox"/> Foam <input type="checkbox"/> Feather/Fiber Mix <input checked="" type="checkbox"/> Feather	Back cushion	<input type="checkbox"/> Fiber <input type="checkbox"/> Foam <input type="checkbox"/> Feather/Fiber Mix <input checked="" type="checkbox"/> Feather
	<b>COMFORT</b>	Standard Comfort <input checked="" type="checkbox"/>		Firm Comfort <input type="checkbox"/>			
	<b>FUNCTION</b>	Bed <input type="checkbox"/>	Electric motion <input type="checkbox"/>	Motion <input type="checkbox"/>	Recliner <input type="checkbox"/>	Sliding <input type="checkbox"/>	
	<b>OPTIONS</b>	Nails <input type="checkbox"/>	Removable <input checked="" type="checkbox"/>	Contrast Stitching <input type="checkbox"/>			

## NOTES

- Seat cushion includes a layer of memory foam, a pressure-sensitive soft polyurethane, that recovers its form completely thus giving great comfort
- Loose Seat Cushion (the seat cushions of the model are not fixed to the frame)
- Wood Frame
- With Feet Assembled (the model will be loaded with feet already mounted on the sofa)
- Plastic Wrap (the model will be wrapped in a plastic bag)
- Feet available in finishing 11 (Metal)
- Feet height 6,0 / 9,0 cm
- It is possible to change feet height (see user's instructions)

NOTES

---



■ vers. 009



■ vers. 009



■ vers. 031





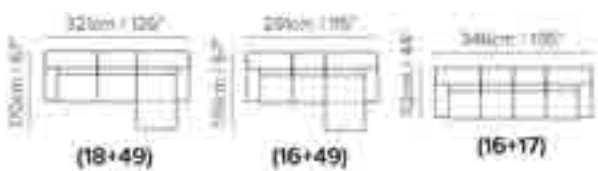

## SCHEMATICS



## COMPOSITION EXAMPLES



## TECHNICAL INFORMATION

	<b>COVERING</b>	Leather <input checked="" type="checkbox"/>					
	<b>LEGS</b>	Wood <input type="checkbox"/>	Metal <input checked="" type="checkbox"/>	Plastic <input type="checkbox"/>	Castors <input type="checkbox"/>	Upholstered <input type="checkbox"/>	
	<b>FILLING</b>	Arms	<input type="checkbox"/> Fiber <input checked="" type="checkbox"/> Foam <input type="checkbox"/> Feather/Fiber Mix <input type="checkbox"/> Feather	Seat cushion	<input type="checkbox"/> Fiber <input checked="" type="checkbox"/> Foam <input checked="" type="checkbox"/> Feather/Fiber Mix <input type="checkbox"/> Feather	Back cushion	<input type="checkbox"/> Fiber <input checked="" type="checkbox"/> Foam <input type="checkbox"/> Feather/Fiber Mix <input type="checkbox"/> Feather
	<b>COMFORT</b>	Standard Comfort <input checked="" type="checkbox"/>	Firm Comfort <input type="checkbox"/>				
	<b>FUNCTION</b>	Bed <input type="checkbox"/>	Electric motion <input type="checkbox"/>	Motion <input type="checkbox"/>	Recliner <input type="checkbox"/>	Sliding <input type="checkbox"/>	
	<b>OPTIONS</b>	Contrast Stitching <input type="checkbox"/>	Removable <input type="checkbox"/>	Nails <input type="checkbox"/>			

## NOTES

- Model is available with thick leather.
- Adjustable headrest on all versions.
- Seat cushion includes a layer of memory foam, a pressure-sensitive soft polyurethane, that recovers its form completely thus giving great comfort
- Loose Seat Cushion (the seat cushions of the model are not fixed to the frame)
- Tight Back Cushion (the back cushions of the models are fixed to the frame)
- No Leather Side (the sectional pieces have the side covered with fabric and not leather)
- Wood Frame
- With Feet Assembled (the model will be loaded with feet already mounted on the sofa)
- Feet available in metal finishing 77 (Glossy Chromed)
- Feet height 12,5 cm

NOTES

---





■ vers. 000 + 002



■ vers. 000 + 002







## SCHEMATICS



## COMPOSITION EXAMPLES



## TECHNICAL INFORMATION

	<b>COVERING</b>	Leather <input checked="" type="checkbox"/>				
	<b>LEGS</b>	Wood <input checked="" type="checkbox"/>	Metal <input type="checkbox"/>	Plastic <input type="checkbox"/>	Castors <input type="checkbox"/>	Upholstered <input type="checkbox"/>
	<b>FILLING</b>	Arms <input type="checkbox"/> Fiber <input checked="" type="checkbox"/> Foam <input type="checkbox"/> Feather/Fiber Mix <input checked="" type="checkbox"/> Feather	Seat cushion <input type="checkbox"/> Fiber <input checked="" type="checkbox"/> Foam <input type="checkbox"/> Feather/Fiber Mix <input checked="" type="checkbox"/> Feather	Back cushion <input type="checkbox"/> Fiber <input checked="" type="checkbox"/> Foam <input type="checkbox"/> Feather/Fiber Mix <input checked="" type="checkbox"/> Feather		
	<b>COMFORT</b>	Standard Comfort <input checked="" type="checkbox"/>	Firm Comfort <input type="checkbox"/>			
	<b>FUNCTION</b>	Bed <input type="checkbox"/>	Electric motion <input type="checkbox"/>	Motion <input type="checkbox"/>	Recliner <input type="checkbox"/>	Sliding <input type="checkbox"/>
	<b>OPTIONS</b>	Nails <input type="checkbox"/>	Removable <input type="checkbox"/>	Contrast Stitching <input type="checkbox"/>		

## NOTES

- Model is available with thick leather.
- Seat cushion includes a layer of memory foam, a pressure-sensitive soft polyurethane, that recovers its form completely thus giving great comfort
- Loose Seat Cushion (the seat cushions of the model are not fixed to the frame)
- With Leather Side (the sectional pieces come with leather sides)
- Without Feet Assembled (the feet will be in a bag inside the package)
- Feet available in wood finishing 29 (Coffee)
- Feet height 20,0 cm

NOTES

---



■ vers. 272 + 274



■ vers. 272 + 291 + 274



■ vers. 113 + 272 + 291 + 274





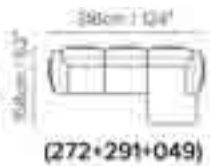

## SCHEMATICS



## COMPOSITION EXAMPLES



## TECHNICAL INFORMATION

	<b>COVERING</b>	Leather <input checked="" type="checkbox"/>				
	<b>LEGS</b>	Wood <input type="checkbox"/>	Metal <input checked="" type="checkbox"/>	Plastic <input type="checkbox"/>	Castors <input type="checkbox"/>	Upholstered <input type="checkbox"/>
	<b>FILLING</b>	Arms <input type="checkbox"/> Fiber <input checked="" type="checkbox"/> Foam <input type="checkbox"/> Feather/Fiber Mix <input type="checkbox"/> Feather	Seat cushion <input type="checkbox"/> Fiber <input checked="" type="checkbox"/> Foam <input type="checkbox"/> Feather/Fiber Mix <input type="checkbox"/> Feather	Back cushion <input type="checkbox"/> Fiber <input checked="" type="checkbox"/> Foam <input type="checkbox"/> Feather/Fiber Mix <input type="checkbox"/> Feather		
	<b>COMFORT</b>	Standard Comfort <input checked="" type="checkbox"/>	Firm Comfort <input type="checkbox"/>			
	<b>FUNCTION</b>	Bed <input type="checkbox"/>	Electric motion <input type="checkbox"/>	Motion <input type="checkbox"/>	Recliner <input type="checkbox"/>	Sliding <input type="checkbox"/>
	<b>OPTIONS</b>	Nails <input type="checkbox"/>	Contrast Stitching <input type="checkbox"/>	Removable <input type="checkbox"/>		

## NOTES

- Model is available with thick leather.
- Loose Seat Cushion (the seat cushions of the model are not fixed to the frame)
- Back Cushion Zippered (the back cushion is attached to the frame through a zipper)
- Arm Cushion Zippered (the arm cushion is attached to the frame through a zipper)
- With Leather Side (the sectional pieces come with leather sides)
- Wood Frame
- With Feet Assembled (the model will be loaded with feet already mounted on the sofa)
- Plastic Wrap (the model will be wrapped in a plastic bag)
- Feet available in metal finishing 78 (Glossy Black)
- Feet height 12,0 cm
- Model is characterized by a special «live cut stitching» (cut pinched stitching).

NOTES

---





■ Vers. 032+291+274+072



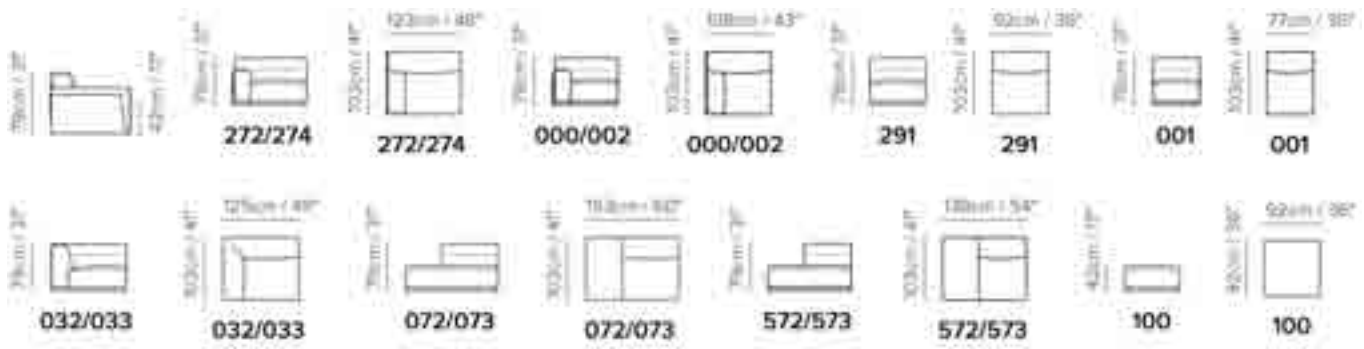



## SCHEMATICS



## COMPOSITION EXAMPLES



## TECHNICAL INFORMATION

	<b>COVERING</b>	Leather <input checked="" type="checkbox"/>					
	<b>LEGS</b>	Wood <input type="checkbox"/>	Metal <input type="checkbox"/>	Plastic <input type="checkbox"/>	Castors <input type="checkbox"/>	Upholstered <input type="checkbox"/>	
	<b>FILLING</b>	Arms <input type="checkbox"/> Fiber <input checked="" type="checkbox"/> Foam <input type="checkbox"/> Feather/Fiber Mix <input checked="" type="checkbox"/> Feather	Seat cushion <input type="checkbox"/> Fiber <input checked="" type="checkbox"/> Foam <input type="checkbox"/> Feather/Fiber Mix <input checked="" type="checkbox"/> Feather	Back cushion <input type="checkbox"/> Fiber <input checked="" type="checkbox"/> Foam <input type="checkbox"/> Feather/Fiber Mix <input checked="" type="checkbox"/> Feather			
	<b>COMFORT</b>	Standard Comfort <input checked="" type="checkbox"/>	Firm Comfort <input type="checkbox"/>				
	<b>FUNCTION</b>	Bed <input type="checkbox"/>	Electric motion <input type="checkbox"/>	Motion <input type="checkbox"/>	Recliner <input type="checkbox"/>	Sliding <input type="checkbox"/>	
	<b>OPTIONS</b>	Nails <input type="checkbox"/>	Removable <input type="checkbox"/>	Contrast Stitching <input type="checkbox"/>			

## NOTES

- Seat cushion includes a layer of memory foam, a pressure-sensitive soft polyurethane, that recovers its form completely thus giving great comfort
- Tight Seat Cushion (the seat cushions of the models are fixed to the frame)
- Tight Back Cushion (the back cushions of the models are fixed to the frame)
- With Leather Side (the sectional pieces come with leather sides)
- Wood Frame
- With Feet Assembled (the model will be loaded with feet already mounted on the sofa)
- Plastic Wrap (the model will be wrapped in a plastic bag)
- Feet height 3,0 cm

NOTES

---



■ Vers. 560



■ Vers. 560







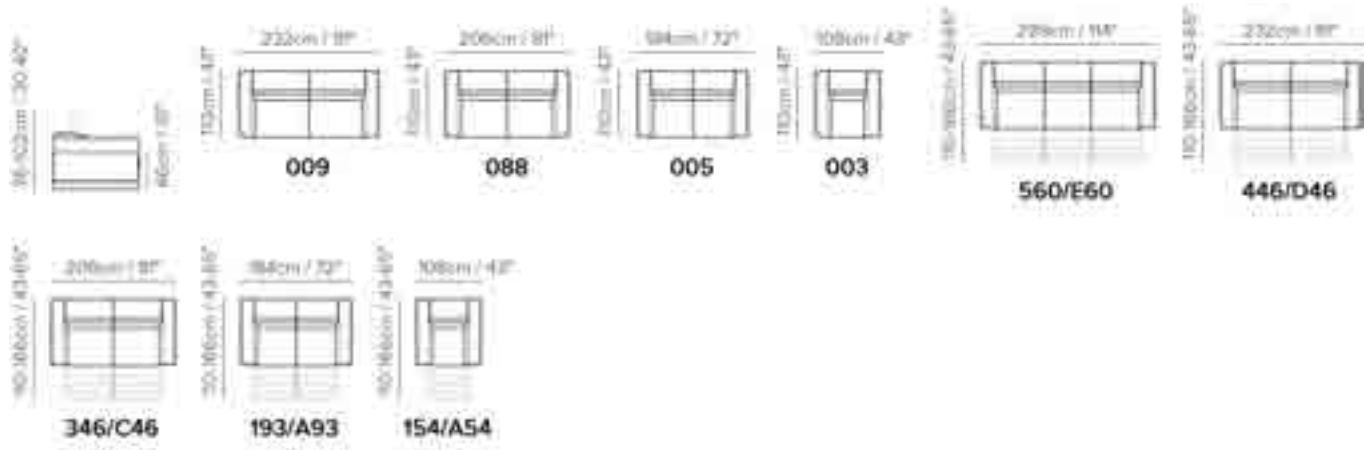

■ Vers. 446

## SCHEMATICS



## TECHNICAL INFORMATION

	<b>COVERING</b>	Leather <input checked="" type="checkbox"/>				
	<b>LEGS</b>	Wood <input type="checkbox"/>	Metal <input checked="" type="checkbox"/>	Plastic <input type="checkbox"/>	Castors <input type="checkbox"/>	Upholstered <input type="checkbox"/>
	<b>FILLING</b>	Arms <input type="checkbox"/> Fiber <input checked="" type="checkbox"/> Foam <input type="checkbox"/> Feather/Fiber Mix <input type="checkbox"/> Feather	Seat cushion <input type="checkbox"/> Fiber <input checked="" type="checkbox"/> Foam <input type="checkbox"/> Feather/Fiber Mix <input type="checkbox"/> Feather	Back cushion <input type="checkbox"/> Fiber <input checked="" type="checkbox"/> Foam <input type="checkbox"/> Feather/Fiber Mix <input type="checkbox"/> Feather		
	<b>COMFORT</b>	Standard Comfort <input checked="" type="checkbox"/>	Firm Comfort <input checked="" type="checkbox"/>			
	<b>FUNCTION</b>	Bed <input type="checkbox"/>	Electric motion <input checked="" type="checkbox"/>	Motion <input type="checkbox"/>	Recliner <input checked="" type="checkbox"/>	Sliding <input type="checkbox"/>
	<b>OPTIONS</b>	Nails <input type="checkbox"/>	Contrast Stitching <input type="checkbox"/>	Removable <input type="checkbox"/>		

## NOTES

- Version 560, a three seater sofa where each seat has its own electric mechanism. The external seats have soft touch buttons on the exterior part of the arm hidden under the covering; the central one has two buttons on the sides of the seat cushion.
- Seat cushion includes a layer of memory foam, a pressure-sensitive soft polyurethane, that recovers its form completely thus giving great comfort
- Adjustable headrest on all versions.
- Tight Seat Cushion (the seat cushions of the models are fixed to the frame)
- Tight Back Cushion (the back cushions of the models are fixed to the frame)
- Wood Frame
- With Feet Assembled (the model will be loaded with feet already mounted on the sofa)
- Plastic Wrap (the model will be wrapped in a plastic bag)
- Feet available in metal finishings 75 (Glazed Nickel) / 78 (Glossy Black)
- Feet height 11,0 cm

NOTES

---





■ vers. 009



■ vers. 066



■ vers. 003



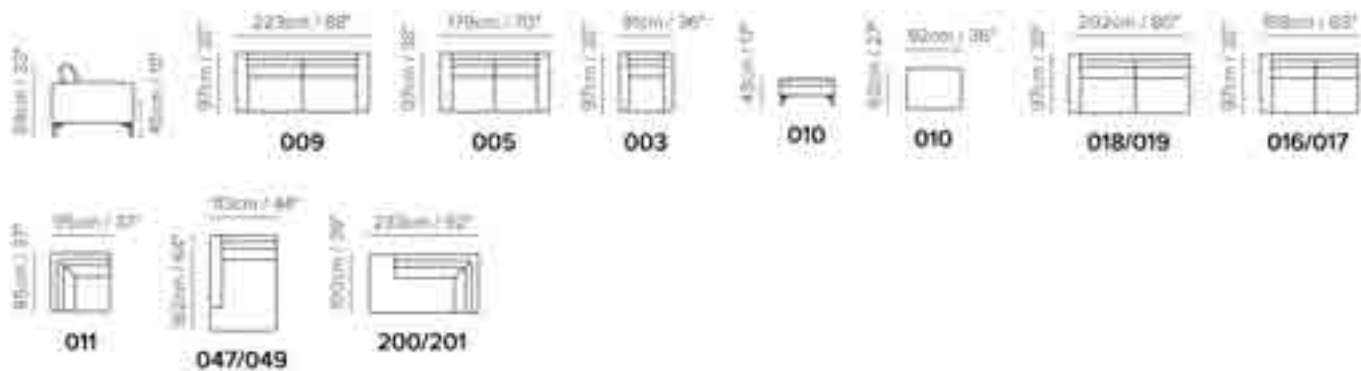

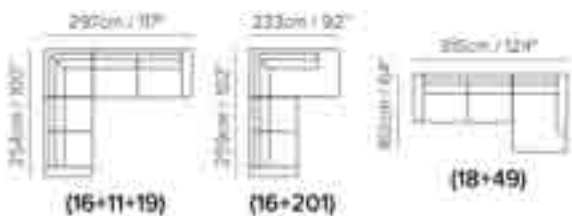

## SCHEMATICS



## COMPOSITION EXAMPLES



## TECHNICAL INFORMATION

	<b>COVERING</b>	Leather <input checked="" type="checkbox"/>	Soft Cover <input checked="" type="checkbox"/>			
	<b>LEGS</b>	Wood <input type="checkbox"/>	Metal <input checked="" type="checkbox"/>	Plastic <input type="checkbox"/>	Castors <input type="checkbox"/>	Upholstered <input type="checkbox"/>
	<b>FILLING</b>	Arms <input type="checkbox"/> Fiber <input checked="" type="checkbox"/> Foam <input type="checkbox"/> Feather/Fiber Mix <input type="checkbox"/> Feather	Seat cushion <input type="checkbox"/> Fiber <input checked="" type="checkbox"/> Foam <input type="checkbox"/> Feather/Fiber Mix <input type="checkbox"/> Feather	Back cushion <input type="checkbox"/> Fiber <input checked="" type="checkbox"/> Foam <input type="checkbox"/> Feather/Fiber Mix <input type="checkbox"/> Feather		
	<b>COMFORT</b>	Standard Comfort <input checked="" type="checkbox"/>	Firm Comfort <input checked="" type="checkbox"/>			
	<b>FUNCTION</b>	Bed <input type="checkbox"/>	Electric motion <input type="checkbox"/>	Motion <input type="checkbox"/>	Recliner <input type="checkbox"/>	Sliding <input type="checkbox"/>
	<b>OPTIONS</b>	Nails <input type="checkbox"/>	Removable <input type="checkbox"/>	Contrast Stitching <input type="checkbox"/>		

## NOTES

- Tight Seat Cushion (the seat cushions of the models are fixed to the frame)
- With Leather Side (the sectional pieces come with leather sides)
- Wood Frame
- Without Feet Assembled (the feet will be in a bag inside the package)
- Plastic Wrap (the model will be wrapped in a plastic bag)
- Feet available in metal finishings 75 (Glazed Nickel) / 77 (Glossy Chromed)
- Feet height 15,0 cm
- In difference to model 2458, V458 does not have quilting on the seat cushion.

NOTES

---



■ vers. 009



■ vers. 009



■ vers. 009



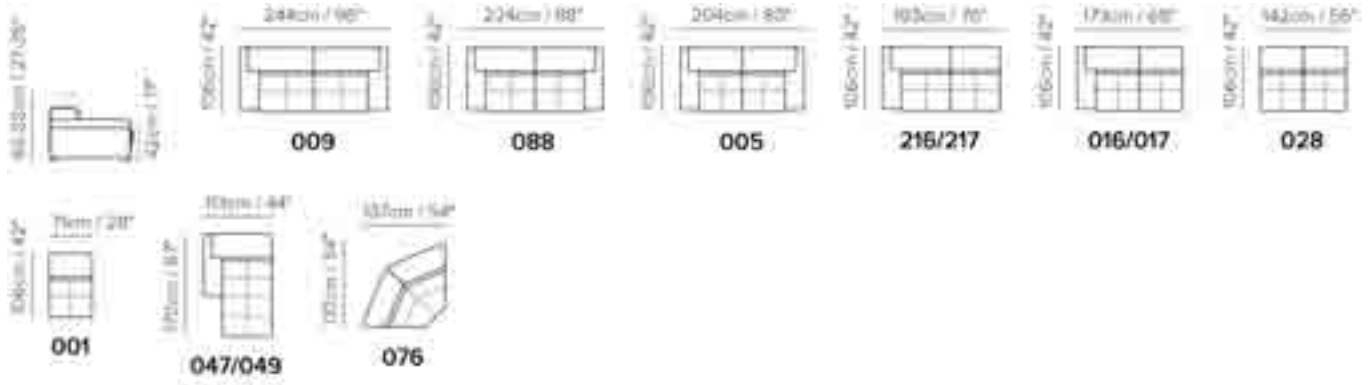

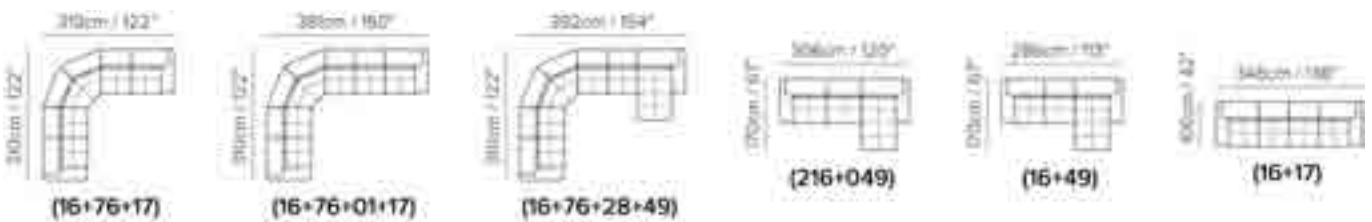

## SCHEMATICS



## COMPOSITION EXAMPLES



## TECHNICAL INFORMATION

	<b>COVERING</b>	Leather <input checked="" type="checkbox"/>				
	<b>LEGS</b>	Wood <input checked="" type="checkbox"/>	Metal <input type="checkbox"/>	Plastic <input type="checkbox"/>	Castors <input type="checkbox"/>	Upholstered <input type="checkbox"/>
	<b>FILLING</b>	Arms <input type="checkbox"/> Fiber <input checked="" type="checkbox"/> Foam <input type="checkbox"/> Feather/Fiber Mix <input type="checkbox"/> Feather	Seat cushion <input type="checkbox"/> Fiber <input checked="" type="checkbox"/> Foam <input type="checkbox"/> Feather/Fiber Mix <input type="checkbox"/> Feather	Back cushion <input type="checkbox"/> Fiber <input checked="" type="checkbox"/> Foam <input type="checkbox"/> Feather/Fiber Mix <input type="checkbox"/> Feather		
	<b>COMFORT</b>	Standard Comfort <input checked="" type="checkbox"/>	Firm Comfort <input type="checkbox"/>			
	<b>FUNCTION</b>	Bed <input type="checkbox"/>	Electric motion <input type="checkbox"/>	Motion <input type="checkbox"/>	Recliner <input type="checkbox"/>	Sliding <input type="checkbox"/>
	<b>OPTIONS</b>	Nails <input type="checkbox"/>	Contrast Stitching <input type="checkbox"/>	Removable <input type="checkbox"/>		

## NOTES

- Model is available only with contrast stitching.
- Adjustable headrest on all versions except the corners.
- Tight Seat Cushion (the seat cushions of the models are fixed to the frame)
- Tight Back Cushion (the back cushions of the models are fixed to the frame)
- No Leather Side (the sectional pieces have the side covered with fabric and not leather)
- Wood Frame
- Without Feet Assembled (the feet will be in a bag inside the package)
- Plastic Wrap (the model will be wrapped in a plastic bag)
- Feet available in wood finishings 09 (Walnut) / 18 (Wengè)
- Feet height 4,5 cm
- Round arm and headrest kit are available in metal finishings 75 and 77.

NOTES

---





■ vers. 009



■ vers. 072 + 399 + 019



■ vers. 072 + 399 + 019



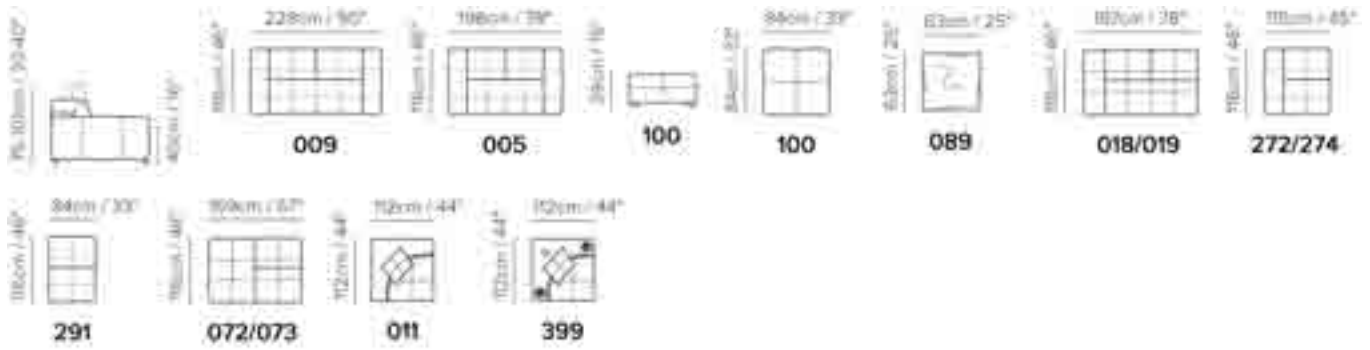



## SCHEMATICS



## COMPOSITION EXAMPLES



## TECHNICAL INFORMATION

	<b>COVERING</b>	Leather <input checked="" type="checkbox"/>					
	<b>LEGS</b>	Wood <input checked="" type="checkbox"/>	Metal <input type="checkbox"/>	Plastic <input type="checkbox"/>	Castors <input type="checkbox"/>	Upholstered <input type="checkbox"/>	
	<b>FILLING</b>	Arms <input type="checkbox"/> Fiber <input checked="" type="checkbox"/> Foam <input type="checkbox"/> Feather/Fiber Mix <input type="checkbox"/> Feather	Seat cushion <input type="checkbox"/> Fiber <input checked="" type="checkbox"/> Foam <input type="checkbox"/> Feather/Fiber Mix <input type="checkbox"/> Feather	Back cushion <input type="checkbox"/> Fiber <input checked="" type="checkbox"/> Foam <input type="checkbox"/> Feather/Fiber Mix <input type="checkbox"/> Feather			
	<b>COMFORT</b>	Standard Comfort <input checked="" type="checkbox"/>	Firm Comfort <input type="checkbox"/>				
	<b>FUNCTION</b>	Bed <input type="checkbox"/>	Electric motion <input type="checkbox"/>	Motion <input type="checkbox"/>	Recliner <input type="checkbox"/>	Sliding <input type="checkbox"/>	
	<b>OPTIONS</b>	Nails <input type="checkbox"/>	Removable <input type="checkbox"/>	Contrast Stitching <input type="checkbox"/>			

## NOTES

- Model is available only with contrast stitching.
- Version 399 includes audio kit.
- Adjustable headrest on all versions.
- Tight Seat Cushion (the seat cushions of the models are fixed to the frame)
- Tight Back Cushion (the back cushions of the models are fixed to the frame)
- No Leather Side (the sectional pieces have the side covered with fabric and not leather)
- Wood Frame
- Without Feet Assembled (the feet will be in a bag inside the package)
- Plastic Wrap (the model will be wrapped in a plastic bag)
- Feet available in wood finishings 09 (Walnut) / 18 (Wengè)
- Feet height 4,5 cm
- Versions 011/399 include 1 small cushion.

NOTES

---



■ Vers. 017+047



■ Vers. 017+047



■ Vers. 017+047



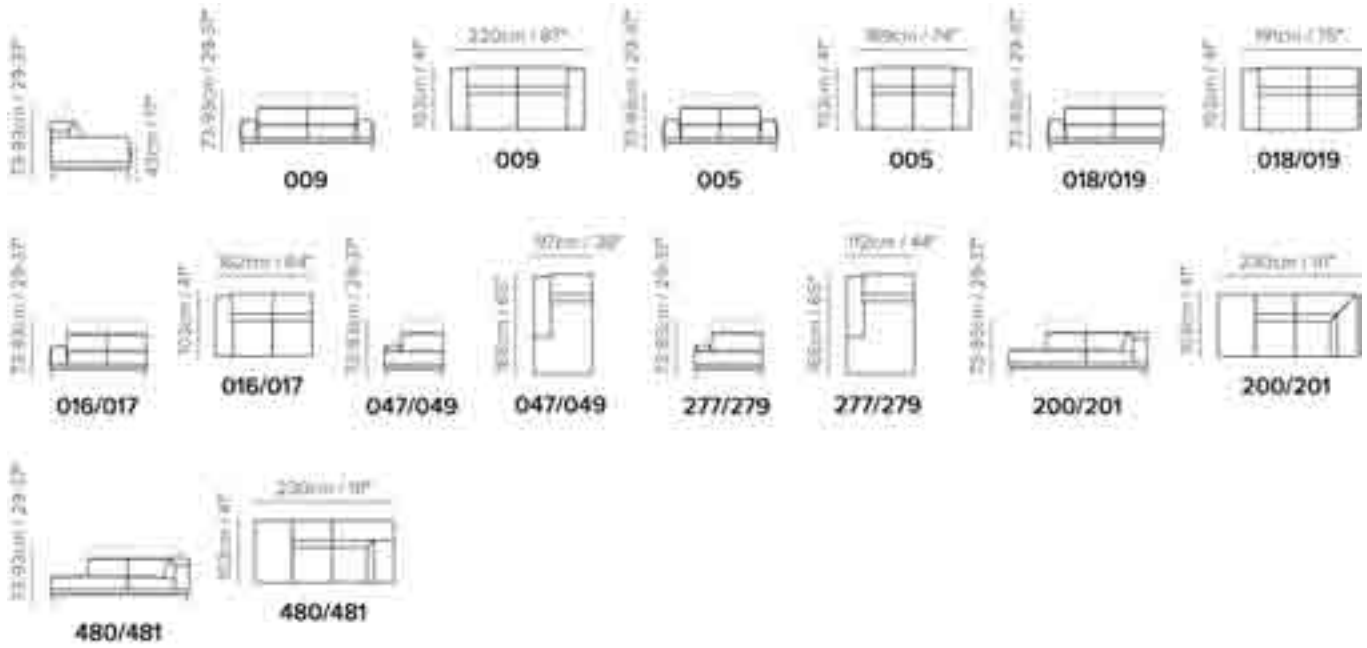



## SCHEMATICS



## COMPOSITION EXAMPLES



## TECHNICAL INFORMATION

	<b>COVERING</b>	Leather <input checked="" type="checkbox"/>	Soft Cover <input checked="" type="checkbox"/>				
	<b>LEGS</b>	Wood <input type="checkbox"/>	Metal <input checked="" type="checkbox"/>	Plastic <input type="checkbox"/>	Castors <input type="checkbox"/>	Upholstered <input type="checkbox"/>	
	<b>FILLING</b>	Arms <input type="checkbox"/>	Fiber <input type="checkbox"/> Foam <input type="checkbox"/> Feather/Fiber Mix <input type="checkbox"/> Feather <input type="checkbox"/>	Seat cushion <input type="checkbox"/>	Fiber <input type="checkbox"/> Foam <input type="checkbox"/> Feather/Fiber Mix <input type="checkbox"/> Feather <input type="checkbox"/>	Back cushion <input type="checkbox"/>	Fiber <input type="checkbox"/> Foam <input type="checkbox"/> Feather/Fiber Mix <input type="checkbox"/> Feather <input type="checkbox"/>
	<b>COMFORT</b>	Standard Comfort <input checked="" type="checkbox"/>	Firm Comfort <input type="checkbox"/>				
	<b>FUNCTION</b>	Bed <input type="checkbox"/>	Electric motion <input type="checkbox"/>	Motion <input type="checkbox"/>	Recliner <input type="checkbox"/>	Sliding <input type="checkbox"/>	
	<b>OPTIONS</b>	Nails <input type="checkbox"/>	Contrast Stitching <input type="checkbox"/>	Removable <input type="checkbox"/>			

## NOTES

- Seat cushion includes a layer of memory foam, a pressure-sensitive soft polyurethane, that recovers its form completely thus giving great comfort
- Tight Seat Cushion (the seat cushions of the models are fixed to the frame)
- Tight Back Cushion (the back cushions of the models are fixed to the frame)
- With Leather Side (the sectional pieces come with leather sides)
- Wood Frame
- Without Feet Assembled (the feet will be in a bag inside the package)
- Plastic Wrap (the model will be wrapped in a plastic bag)
- Metal base available in metal finishings 75 (Glazed Nickel) / 78 (Glossy Black)
- Feet height 16,0 cm

NOTES

---